

# User Guide

htc Incredible™ with Google™



# Before you do anything else, please read this

---

## Charge the battery

The battery in your phone hasn't been charged yet. While your phone is charging, it's important that you do not remove the battery pack. Doing so can damage your phone. Also, please don't try to take your phone apart. (If you do, it may invalidate your warranty.)

## Choose a rate plan wisely

Your phone can use up a lot of Internet bandwidth really quickly. Before you use your phone, we strongly recommend that you talk to your mobile operator about data rates. If you're on a standard data plan, the costs could really add up. Switching to a flat-rate plan could be a lot cheaper.

## Know about privacy laws

Some countries have strict laws about how and when you can record phone conversations. For example, you may need to tell the person you're speaking to before you start recording. It's a good idea to find out what the laws are where you live before you use your phone's recording feature.

## And finally, a few important words from our legal team (LIMITATION OF DAMAGES)

To the maximum extent permitted by applicable law, in no event shall HTC or its affiliates be liable to you, any user, or third party for any indirect, special, consequential, incidental or punitive damages of any kind, arising in contract, tort, or otherwise, including, but not limited to, injury, loss of revenue, loss of goodwill, loss of business opportunity, loss of data, and/or loss of profits, regardless of the foreseeability thereof or whether HTC or its affiliates have been advised of the possibility of such damages. And in no event shall the total liability of HTC or its affiliates exceed the amount received from you, regardless of the legal theory under which the cause of action is brought. The foregoing does not affect any statutory rights which may not be disclaimed.

Please also read the Safety and regulatory guide that is included in the box for information on the proper usage of your phone to prevent injuries and to avoid damaging your phone. You can also refer to this guide for regulatory information about your phone.

You can also visit our support website at [www.htc.com/support](http://www.htc.com/support) to download the Safety and regulatory guide and to access other helpful resources for your phone.

## Notice

Screen images and icons are simulated. Actual display may vary. Instructions in this guide may change depending on the software version on your wireless device.

# Trademarks and copyrights

---

Copyright © 2010 HTC Corporation. All Rights Reserved.

The HTC logo, the HTC quietly brilliant logo, HTC Incredible, HTC Sense, Footprints, HTC Sync, and HTC Care are trademarks and/or service marks of HTC Corporation.

Copyright © 2010 Google Inc. Used with permission.

Google, the Google logo, Android, Google Search, Google Maps, Gmail, Google Mail, YouTube, Android Market, and Google Talk are trademarks of Google Inc.

Google, the Google logo and Google Maps are trademarks of Google, Inc. TeleAtlas® Map Data ©2010. Street View Images ©2010 Google.

Microsoft, Windows, Windows XP, Windows Vista, Active Sync, and Outlook are either registered trademarks or trademarks of Microsoft Corporation in the United States and/or other countries.

Bluetooth and the Bluetooth logo are trademarks owned by Bluetooth SIG, Inc.

Wi-Fi is a registered trademark of the Wireless Fidelity Alliance, Inc.

microSD is a trademark of SD Card Association.

Java, J2ME and all other Java-based marks are trademarks or registered trademarks of Sun Microsystems, Inc. in the United States and other countries.

Facebook is a trademark of Facebook, Inc.

Twitter is a trademark of Twitter, Inc., and is used under license.

Flickr is a trademark of Yahoo! Inc.

Licensed by QUALCOMM Incorporated under one or more of the following patents:

4,901,307 5,490,165 5,056,109 5,504,773 5,101,501 5,778,338 5,506,865 5,109,390 5,511,073  
5,228,054 5,535,239 5,710,784 5,267,261 5,544,196 5,267,262 5,568,483 5,337,338 5,659,569  
5,600,754 5,414,796 5,657,420 5,416,797

All other company, product and service names mentioned herein are trademarks, registered trademarks or service marks of their respective owners.

HTC shall not be liable for technical or editorial errors or omissions contained herein, nor for incidental or consequential damages resulting from furnishing this material. The information is provided "as is" without warranty of any kind and is subject to change without notice.

HTC also reserves the right to revise the content of this document at any time without prior notice.

No part of this document may be reproduced or transmitted in any form or by any means, electronic or mechanical, including photocopying, recording or storing in a retrieval system, or translated into any language in any form without prior written permission of HTC.

## Conventions used in this guide

---

In this user guide, we use the following symbols to indicate useful and important information:



This is a note. A note often gives additional information, such as what happens on your phone when you choose to do or not to do a certain action. A note also provides information that may only be applicable to some situations.



This is a tip. A tip gives you an alternative way to do a particular step or procedure, or lets you know of an option that you may find helpful.



This indicates that something is very important. Important information is something that you need to do in order to accomplish a certain task or to get a phone feature to work properly.



This provides safety precaution information, that is, information that you need to be careful about to prevent potential problems when using your phone.

## IMPORTANT CUSTOMER INFORMATION

---

Please be advised that many services and applications offered through this unique device are provided by various device, operating system, software and application developers (e.g. Google, Motorola, Microsoft, Palm). If you use, link to or download such a service, or an application such as a non-Verizon Wireless location based GPS-type service, chat room, marketplace or social network from this device, you should carefully review the terms of such service or application. If you use any of these non-Verizon Wireless services or applications, personal information you submit may be read, collected, or used by the service or application provider and/or other users of those forums.

Verizon Wireless is not responsible for your use of those applications or information you choose to submit or share with others. Specific terms and conditions, terms of use, and privacy policies apply to those applications and services. Please review carefully any and all terms and conditions applicable to those applications and services including those related to any location-based services for any particular privacy policies, risks or waivers.

Your Verizon Wireless Customer Agreement Terms and Conditions and certain other specifically identified terms govern your use of any Verizon Wireless products and services.

# Contents

## Basics

Inside the box .....	14
Your Phone.....	14
Front panel .....	14
Back panel .....	15
Top panel.....	16
Left panel.....	16
Before turning on your phone .....	17
Back cover .....	17
Storage card .....	17
Battery .....	18
Finger gestures.....	20
Getting started .....	21
Turning on your phone .....	21
Turning off your phone.....	21
Setting up your phone for the first time .....	21
Sleep mode.....	22
Home screen .....	24
Extended Home screen.....	24
Navigating the Home screen .....	24
Phone status and notifications.....	25
Phone status icons.....	25
Notification icons.....	26
Checking notifications .....	27
Adjusting the volume.....	28
Adjusting the ringer volume .....	28
Adjusting the media volume.....	28
Connecting your phone to a computer .....	29
Copying files to and from the storage card .....	30
Searching your phone and the Web .....	31
Setting Web and Quick Search Box options .....	31
Searching the Web and your phone using the Quick Search Box .....	31

## Personalizing

Making your phone truly yours .....	32
Changing the ringtone .....	32
Personalizing your phone with scenes.....	33
Using a preset scene.....	33
Customizing and saving a scene .....	33
Renaming or deleting a scene .....	34
Changing your wallpaper .....	35
Personalizing your Home screen with widgets.....	36
Adding a widget to your Home screen .....	36
Downloading HTC widgets.....	36
Adding application icons and other shortcuts on your Home screen .....	37

<b>Adding folders on your Home screen .....</b>	<b>38</b>
Creating a new folder and adding items to it.....	38
Renaming a folder.....	38
<b>Rearranging or removing widgets and icons on your Home screen.....</b>	<b>39</b>
Moving a widget or icon .....	39
Removing a widget or icon .....	39

## Phone calls

<b>Making calls .....</b>	<b>40</b>
Calling somebody using your phone .....	40
Calling a speed dial number.....	40
Calling using Voice Dialer.....	41
Calling a phone number in a text message .....	41
Calling a phone number in an email.....	41
Making an emergency call .....	42
Using Assisted Dialing.....	42
<b>Receiving calls .....</b>	<b>43</b>
Answering an incoming call .....	43
Rejecting an incoming call.....	44
Rejecting a call and sending a text message.....	44
<b>Using in-call options.....</b>	<b>45</b>
Handling multiple calls.....	45
Setting up a conference call .....	45
Muting the microphone during a call.....	46
Turning the speakerphone on or off during a call.....	46
Ending a call .....	46
<b>Using call history .....</b>	<b>47</b>
Adding a new phone number to your contacts from call history .....	47
Checking a missed call.....	48
Clearing the call history list .....	48
<b>Call services.....</b>	<b>49</b>
<b>Visual Voice Mail .....</b>	<b>50</b>
Setting up Visual Voice Mail.....	50
Using Visual Voice Mail.....	50
<b>Turning Airplane mode on or off .....</b>	<b>51</b>

## People

<b>About People.....</b>	<b>52</b>
<b>Ways of getting contacts into your phone.....</b>	<b>52</b>
<b>People screen .....</b>	<b>53</b>
Setting up My contact card.....	53
Your contacts list.....	53
Adding a new contact.....	54
Importing contacts from an Exchange ActiveSync account .....	55
Merging contact information.....	55
Editing a contact's information .....	55
Searching for a contact.....	56
Backing up your contacts to the storage card.....	56
Importing contacts from the storage card .....	56
Deleting contacts .....	56
Sending contact information as a vCard via MMS.....	56
Sending your contact information as a vCard via MMS .....	57

<b>Contact groups .....</b>	<b>58</b>
Creating a group and adding contacts.....	58
Deleting a group.....	58
Adding or removing contacts from a group.....	58
Sending an SMS/MMS message or email to a group.....	59
<b>Contact information and conversations .....</b>	<b>60</b>
<b>People widget.....</b>	<b>61</b>
Adding the People widget.....	61
Setting the default communication method.....	61
Changing the default communication method.....	61
Getting in touch with a contact.....	61

## Keyboard

<b>Using the onscreen keyboard.....</b>	<b>62</b>
Using the landscape onscreen keyboard.....	62
Changing the onscreen keyboard layout.....	62
Entering text.....	63
Entering words with predictive text.....	63
Entering text with voice input.....	64
<b>Adjusting touch input settings.....</b>	<b>65</b>
Touch Input settings .....	65
Text input.....	65

## Messages

<b>About Messages .....</b>	<b>67</b>
Sending text and multimedia messages.....	67
<b>New message notifications.....</b>	<b>70</b>
<b>WAP push messages.....</b>	<b>71</b>
<b>Managing message conversations.....</b>	<b>72</b>
Protecting a message from deletion.....	73
Deleting a message thread.....	73
Deleting several message threads .....	73
Deleting a single message .....	73
Viewing contact details and communicating with a contact.....	73
<b>Setting text and multimedia message options.....</b>	<b>74</b>
<b>Adding the Messages widget .....</b>	<b>75</b>

## Accounts and sync

<b>Synchronizing with online accounts .....</b>	<b>76</b>
Adding a social network account.....	76
Synchronizing with a Google Account.....	76
Synchronizing with a Microsoft Exchange ActiveSync account.....	77
Managing your accounts .....	77
<b>Using HTC Sync.....</b>	<b>78</b>
Installing HTC Sync.....	78
Setting up HTC Sync to recognize your phone.....	79
Setting up synchronization.....	79
Setting up more sync options.....	80
Synchronizing your phone.....	80
Downloading the latest HTC Sync upgrade.....	81
Installing apps from your computer to your phone.....	81

## Social

<b>Facebook for HTC Sense and Facebook for Android application.....</b>	<b>82</b>
Facebook for HTC Sense .....	82
Facebook for Android application.....	82
Differences between Facebook for HTC Sense and Facebook for Android application ...	83
<b>Twittering on your phone.....</b>	<b>84</b>
Peep screen.....	84
Sending a tweet .....	84
Searching for Twitter users to follow.....	85
Sending a direct message.....	85
Setting Peep options .....	85
Adding the Twitter widget.....	86
<b>Using Friend Stream.....</b>	<b>87</b>
Friend Stream screen .....	87
Updating your status.....	88
Adding the Friend Stream widget.....	88
<b>Chatting in Google Talk.....</b>	<b>89</b>
Signing in to Google Talk.....	89
Chatting with friends.....	89
Changing your online status and picture.....	90
Managing your Friends list.....	91
Changing Google Talk settings.....	92

## Email

<b>Using Gmail/Google Mail .....</b>	<b>94</b>
Viewing your Gmail/Google Mail inbox .....	94
Reading your messages.....	95
Sending a message.....	97
Managing conversations and messages.....	98
Changing Gmail/Google Mail settings .....	100
<b>Mail.....</b>	<b>101</b>
Adding a POP3/IMAP email account .....	101
Viewing your email inbox .....	101
Exchange ActiveSync email.....	103
Composing and sending an email message.....	104
Viewing and replying to an email message.....	105
Editing email account settings .....	105
Deleting an email account .....	105
Adding the Mail widget.....	105

## Calendar

<b>About Calendar.....</b>	<b>106</b>
<b>Creating a calendar event.....</b>	<b>106</b>
Inviting guests to your event (Google Account only).....	107
Sending a meeting request using Calendar (Exchange ActiveSync only).....	107
<b>Changing calendar views .....</b>	<b>108</b>
Month view .....	108
Day and Agenda views.....	109
Week view.....	110
<b>Viewing, editing or deleting an event.....</b>	<b>111</b>
Viewing and editing an event.....	111
Deleting an event.....	111



Calendar event reminders .....	112
Viewing, dismissing, or snoozing event reminders .....	112
Displaying and synchronizing calendars .....	113
Showing or hiding calendars .....	113
Choosing which Google Calendars are synchronized on your phone .....	113
Changing Calendar settings .....	114
Reminder settings .....	114
Calendar view settings .....	114
Sending a vCalendar .....	115
About the Calendar widget .....	115

## Clock and Weather

About the HTC Clock widget .....	116
About the Clock application .....	117
Using Desk Clock .....	118
Using World Clock .....	119
Setting your home city .....	119
Setting the time zone, date, and time .....	119
Adding a city to the World Clock screen .....	120
Setting the alarm clock .....	121
Setting an alarm .....	121
Deleting an alarm .....	121
Changing alarm sound settings .....	122
Checking weather .....	123
Adding a city to the Weather screen .....	123
Changing the order of cities on the Weather screen .....	124
Deleting cities from the Weather screen .....	124
Changing weather options .....	124
About the Weather widget .....	124

## Internet

Data connection .....	125
Turning the data connection on or off .....	125
Enabling data roaming .....	125
Wi-Fi .....	126
Turning Wi-Fi on and connecting to a wireless network .....	126
Connecting to a Wi-Fi network with EAP-TLS security .....	126
Checking the wireless network status .....	127
Connecting to another Wi-Fi network .....	127
Adding the Data connection and Wi-Fi widgets .....	128
Connecting to a virtual private network (VPN) .....	129
Preparing your phone for VPN connection .....	129
Adding a VPN connection .....	129
Connecting to a VPN .....	129
Disconnecting from a VPN .....	130
Using your phone's web browser .....	131
Opening the browser .....	131
Going to a web page .....	131
Setting your home page .....	131
Changing the screen orientation .....	131

- Browsing full versions of all web sites..... 131
- Navigating on a web page..... 132
- Zooming in or out on a web page ..... 132
- Selecting a link in a web page..... 132
- Opening a new browser window ..... 133
- Switching between browser windows ..... 133
- Finding text within a web page..... 134
- Downloading applications from the web..... 134
- Copying text, looking up information, and sharing ..... 134
- Viewing bookmarks and previously visited pages..... 136
- Setting browser options..... 137

- Using your phone as a modem (tethering).....138

## Bluetooth

- Using Bluetooth .....139
  - Turning Bluetooth on or off..... 139
  - Changing the phone name ..... 139
- Connecting a Bluetooth headset or car kit ..... 140
  - Reconnecting a headset or car kit..... 140
- Disconnecting or unpairing from a Bluetooth device .....141
  - Disconnecting a Bluetooth device..... 141
  - Unpairing from a Bluetooth device ..... 141
- Sending and receiving information using Bluetooth .....142
  - Sending information from your phone to another device ..... 142
  - Receiving information from another device..... 143

## Camera

- Camera basics..... 145
  - Viewfinder screen..... 145
  - Using the optical joystick as the shutter release ..... 146
  - Review screen ..... 146
- Zooming.....147
- Taking a photo..... 148
  - Capturing a video..... 149
- Camera settings..... 150
  - Changing basic settings.....150
  - Changing advanced settings .....150

## Photos

- About the Photos application .....152
- Selecting an album .....152
- Viewing photos and videos .....153
  - Browsing in filmstrip or grid view..... 153
  - Viewing a photo in landscape orientation ..... 154
  - Zooming in or out on a photo..... 154
  - Watching video ..... 154
- Viewing photos in your social networks.....155
  - Viewing photos on Facebook..... 155
  - Viewing photos on Flickr ..... 155

<b>Working with photos</b> .....	<b>156</b>
Rotating and saving a photo .....	156
Cropping a photo .....	156
<b>Sharing</b> .....	<b>157</b>
Sending photos or videos by email .....	157
Sending a photo or video by MMS .....	157
Sending photos or videos using Bluetooth .....	157
Sharing photos on Facebook .....	158
Sharing photos on Flickr .....	158
Sharing photos on Picasa .....	158
Sharing videos on YouTube .....	158

## Music

<b>About the Music application</b> .....	<b>159</b>
<b>Playing music</b> .....	<b>159</b>
<b>Browsing music in the Library</b> .....	<b>160</b>
<b>Creating a playlist</b> .....	<b>161</b>
Playing the songs in a playlist .....	161
Managing playlists .....	161
<b>Setting a song as ringtone</b> .....	<b>163</b>
Checking if the song was added as a ringtone .....	163
<b>Sending music using Bluetooth</b> .....	<b>163</b>
<b>About the Music widget</b> .....	<b>163</b>

## Maps and location

<b>Using Google Maps</b> .....	<b>164</b>
Viewing locations .....	164
Viewing map layers .....	166
Searching for a location .....	167
Getting directions .....	168
Finding your friends with Google Latitude (available by country) .....	169
<b>Using HTC Footprints</b> .....	<b>172</b>
Creating a footprint .....	172
Revisiting a footprint .....	172
Editing or deleting a footprint .....	173
Exporting your footprints .....	173
Importing footprints .....	174
Adding the Footprints widget .....	174

## More apps

<b>Watching videos on YouTube</b> .....	<b>175</b>
Watching videos .....	175
Searching for videos .....	175
Sharing a video link .....	176
Capturing a video and sharing it on YouTube .....	176
<b>Viewing a PDF</b> .....	<b>177</b>
<b>Viewing documents, presentations, and spreadsheets</b> .....	<b>178</b>
<b>Keeping track of your stocks</b> .....	<b>179</b>
Adding a stock quote or stock market index .....	179
Changing the stock list order .....	179

Deleting stock quotes and indices.....	179
Setting stock information update frequency.....	180
Manually updating stock information.....	180
Adding the Stocks widget .....	180
<b>Listening to the radio.....</b>	<b>181</b>
Listening to an FM station.....	181
Adding station names.....	182
Minimizing or turning off FM Radio.....	182
<b>Recording your voice.....</b>	<b>183</b>
Recording your voice.....	183
Sharing a voice clip.....	183
Setting a voice clip as a ringtone .....	183
Renaming a voice clip .....	183
<b>Using Voice Search.....</b>	<b>184</b>
Opening Voice Search.....	184
<b>Navigator.....</b>	<b>185</b>
Opening Navigator .....	185
<b>Finding and installing apps from Android Market.....</b>	<b>186</b>
Finding and installing an application.....	186
Creating a Google Checkout account.....	187
Requesting a refund for an application.....	187
Opening an installed application .....	188
Uninstalling an application.....	188
Getting help .....	188

## Security

Protecting your phone with a screen lock.....	189
---	-----

## Settings

Settings on your phone.....	190
<b>Changing display settings.....</b>	<b>192</b>
Adjusting the screen brightness manually.....	192
Adjusting the time before the screen turns off .....	192
Preventing automatic screen rotation.....	192
Recalibrating the G-sensor .....	192
Switching animation effects on or off.....	193
Keeping the screen on while charging the phone.....	193
<b>Changing sound settings.....</b>	<b>194</b>
<b>Changing the phone language.....</b>	<b>195</b>
<b>Optimizing your phone's battery life.....</b>	<b>196</b>
Checking the power usage of applications .....	196
<b>Managing memory.....</b>	<b>197</b>
Checking how much phone memory is available for use.....	197
Checking the available storage card space.....	197
Clearing application cache and data .....	197
Uninstalling third-party applications.....	197
Freeing up more phone memory or storage card space.....	197
<b>Checking information about your phone.....</b>	<b>198</b>

## Backup, update and reset

Backing up your contacts .....	199
Setting up Backup Assistant.....	199
Changing the backup schedule.....	199
Manually backing up your contacts .....	199
Updating your phone's system software.....	200
Checking for phone system software updates manually.....	200
Performing a hard/factory reset.....	201

## Specifications

## Index

# Basics

## Inside the box

---

You will find the following inside the box:

- Phone
- USB cable
- Battery
- AC adapter
- Quick start guide
- RF brochure
- Product safety and warranty brochure

## Your Phone

---

### Front panel

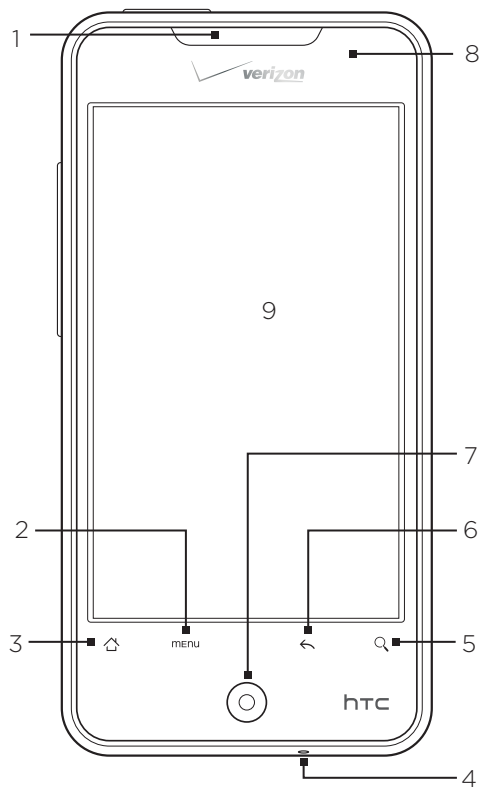

---

#### 1 Earpiece

Listen to a phone call from here.

---

#### 2 MENU

Press to open a list of actions that you can do on the current screen.

---

---

**3 HOME**

- While on any application or screen, press to return to the Home screen.
- While on the main Home screen, press to show a snapshot of the extended Home screens.
- Press and hold to open the recently-used applications window.

---

**4 Microphone**

---

**5 SEARCH**

Press to open the Quick Search box.

See “Searching your phone and the Web” in this chapter for more details.

---

**6 BACK**

Press to go back to the previous screen, or to close a dialog box, options menu, the Notifications panel, or onscreen keyboard.

---

**7 Optical joystick**

Swipe your finger over or press to highlight or select items onscreen.

---

**8 Notification LED**

This LED shows a:

- Solid green light when the phone is connected to the power adapter or a computer and the battery is fully charged.
- Flashing green light when you have a pending notification.
- Solid red light when the battery is being charged.
- Flashing red light when the battery level reaches very low.

---

**9 Touch screen**

---

**Back panel**

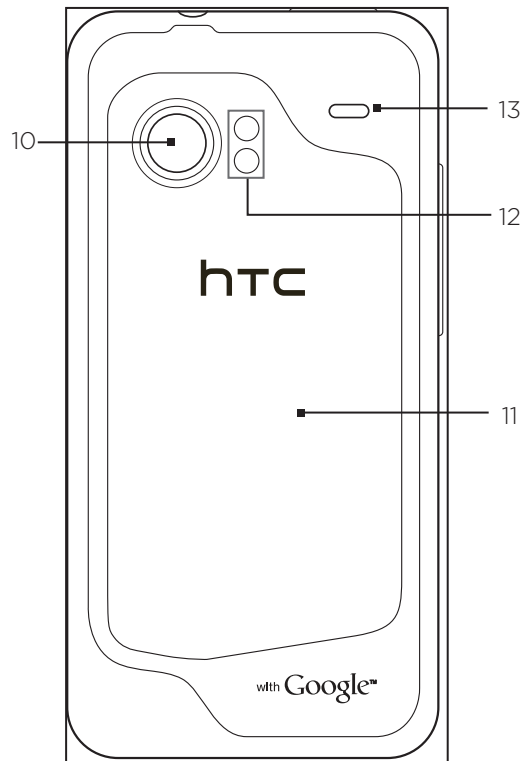

---

10 8 megapixel camera

---

11 Back cover

---

12 Dual LED flashlight

---

13 Speaker

---

## Top panel

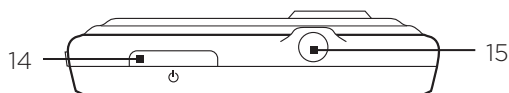

---

### 14 POWER

- When the phone is off, press to turn on the phone.
- When the phone is on and the screen is unlocked, press to turn the phone display off or on.
- With the screen unlocked, press and hold to open the phone options menu that lets you turn off the phone, switch your phone to silent mode, vibration mode, or airplane mode, and turn on/off the data connection.

---

### 15 3.5mm audio jack

Connect a 3.5mm stereo headset for hands-free conversation or for listening to music.

---

## Left panel

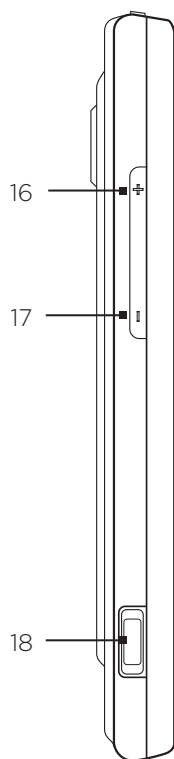

---

### 16 VOLUME UP

- While on a call, press to increase earpiece volume.
- While not on a call, press to increase the ringer volume.
- While watching videos or listening to the FM radio, press to increase the volume.

---

### 17 VOLUME DOWN

- While on a call, press to decrease earpiece volume.
- While not on a call, press to decrease the ringer volume.
- While watching videos or listening to the FM radio, press to decrease the volume.

---

### 18 USB connector

- Connect the power adapter to charge the battery.
  - Connect the supplied USB cable to transfer files to your phone from your computer or sync your phone with HTC Sync on your computer.
-



# Before turning on your phone

---

## Back cover

### Removing the back cover

Remove the back cover to access the battery compartment and storage card slot.

1. With the phone turned off, hold your phone securely with the front facing down.
2. With your thumb or finger, lift up the back cover from the notch at the bottom of the wireless device.

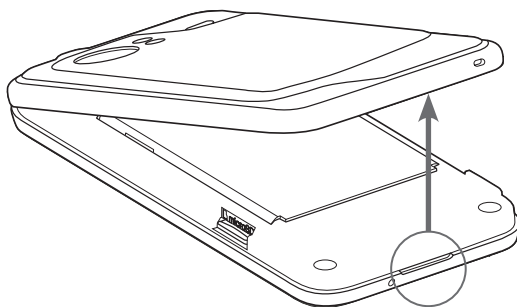

### Replacing the back cover

1. Align and secure the top part of the back cover first.
2. Press the sides and the bottom part of the back cover down to lock the cover into place. You will hear a click when the back cover is locked in place.

## Storage card

Store your pictures, music, and applications in the microSD card (sold separately).

### Inserting the storage card

1. Remove the back cover. Refer to “Removing the back cover.”
2. If the battery is installed, remove the battery. Refer to “Removing the battery.”
3. Insert the microSD card into the slot with its gold contacts facing down and push it in until it clicks into place.

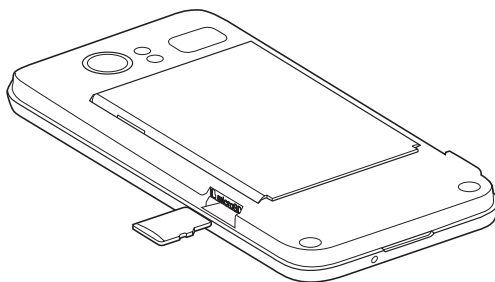

### Removing the storage card

1. Remove the back cover. Refer to “Removing the back cover.”
2. If the battery is installed, remove the battery. Refer to “Removing the battery.”
3. Push the storage card in to eject it from its slot.

## Removing the storage card while the phone is on

When you need to remove the storage card while the phone is on, unmount the storage card first to prevent corrupting or damaging the files in the storage card.

1. Press HOME  > MENU, and then tap **Settings**.
2. Scroll down the screen, and then tap **SD card & phone storage**.
3. Tap **Unmount SD card**.
4. Remove the storage card by following the instructions in “Removing the storage card.”

## Battery

Your phone comes with a rechargeable Lithium-ion polymer or Lithium-ion battery and is designed to use only manufacturer-specified original batteries and accessories. Battery performance depends on many factors, including network configuration, signal strength, the temperature of the environment in which you operate your phone, the features and/or settings you select and use, items attached to connecting ports, and your voice, data, and other program usage patterns.

### Inserting the battery

1. Remove the back cover. Refer to “Removing the back cover.”
2. Insert the contacts side of the battery first and then gently push the battery into place.

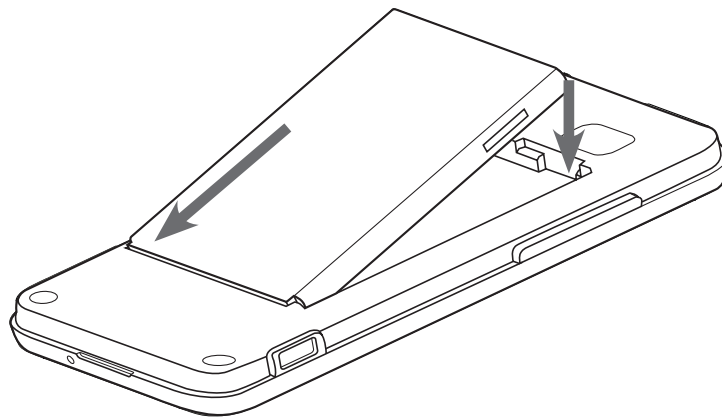

### Removing the battery

1. Remove the back cover. Refer to “Removing the back cover.”
2. Lift out the battery from the notch near the speaker.

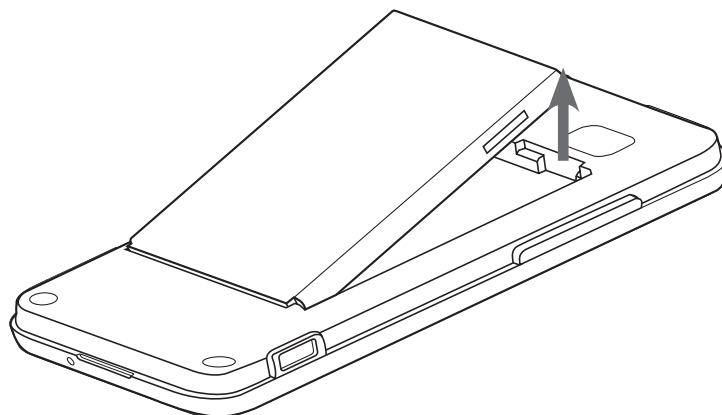

## Charging the battery

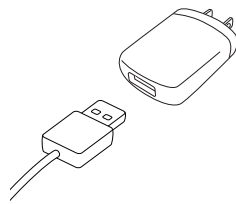

The battery is partially charged when shipped. Before you turn on and start using your phone, it is recommended that you charge the battery. Some batteries perform best after several full charge/discharge cycles.

1. Attach the power plug to the AC adapter.
2. Connect one end of the USB cable to the sync connector on your phone.
3. Connect the other end of the USB cable to the USB port of the AC adapter.



4. Plug the AC adapter into an electrical outlet to start charging the battery.

As the battery is being charged, the notification LED shows a solid red light when the battery is being charged. The light turns to solid green when the phone is fully charged.

When you charge the battery while the phone is on, the charging battery icon (  ) is displayed in the status bar of the Home screen. After the battery has been fully charged, a full battery icon (  ) will be displayed in the status bar of the Home screen.



- Use only an approved charging accessory to charge your phone.
- Do not remove the battery from the phone while you are charging it using the AC or car adapter.
- As a safety precaution, the battery stops charging when it overheats.

## Finger gestures

### Tap

When you want to type using the keyboard, select items onscreen such as application and settings icons, or press onscreen buttons, simply tap them with your finger.

### Press and hold

To open the available options for an item (e.g. contact or link in a web page), simply press and hold the item.

### Swipe or slide

To swipe or slide means to quickly drag your finger vertically or horizontally across the screen or optical joystick.

### Drag

Press and hold your finger with some pressure before you start to drag. While dragging, do not release your finger until you have reached the target position.

### Flick

Flicking the screen is similar to swiping, except that you need to swipe your finger in light, quicker strokes. This finger gesture is always in a vertical direction, such as when flicking the contacts or message list.

### Rotate

For most screens, you can automatically change the screen orientation from portrait to landscape by rotating the phone to the left. When entering text, you can turn the phone sideways to bring up a bigger keyboard. Refer to the Settings chapter for more details.

### Pinch

For some applications, like Photos or the web browser, you can “pinch” the screen using 2 fingers (for example, thumb and index fingers) to zoom in or zoom out when viewing a picture or a web page.

# Getting started

---

Once you've installed your battery, you can turn on your phone and start using it.

## Turning on your phone

Press the POWER button.



When you turn on the phone for the first time, you will be prompted to set up your phone. For more information on how to set up your phone for the first time, see "Setting up your phone for the first time."

## Turning off your phone

If you do not need to use your phone, you can turn the power off to save battery life.

1. If the display is off, press the POWER button to turn the display back on.
2. Unlock your phone if the Lock screen is displayed. See "Unlocking the screen" in this chapter for details.
3. Press and hold the POWER button for a few seconds.
4. When the Phone options options menu appears, tap **Power off**.
5. Tap **OK** when prompted to turn off the phone.

## Setting up your phone for the first time

When you turn on your phone for the first time, your phone displays tutorials and guides you to set up your email accounts and favorite social networks such as Facebook®, YouTube™, and Twitter™. You can follow the onscreen instructions to complete the setup, or skip the setup and do it at another time.

1. Choose the phone language you want to use, and then tap **Next**.
2. Your phone walks you through a tutorial on how to use the onscreen keyboard. Follow through the tutorial to learn how to use the onscreen keyboard. Tap **Skip** to not go through the tutorial.
3. On the Internet connection screen, select how you want to connect to the Internet, and then tap **Next**.
4. If there are Wi-Fi networks in range, you will be asked if you want to connect to a Wi-Fi network. Tap **Next** and then tap the wireless network that you want, or clear the **Connect to Wi-Fi network** checkbox, and then tap **Next** to set up your Wi-Fi connection at a later time.
5. Some phone features such as Weather and Footprints require Google's location service to automatically determine your current location. On the Location consent screen, you can choose whether to allow Google's location service to collect information about your location. Clear or select the checkbox, and then tap **Next**.



This service may incur additional data transfer fees from your provider. You can enable or disable this service later in your phone's location settings.

6. On the Set up accounts screen, choose the type of account you want to set up and follow the onscreen instructions to complete the setup. Tap **Skip** to set up accounts at a later time.
  - To set up Verizon Backup Assistant, tap **Backup Assistant** and follow the instructions on the screen to sign in.
  - To set up your Google Account, tap **Google account > Next > Sign in**, enter your Google Account details, and then tap **Sign in**.
  - To learn how to set up POP3 and Microsoft Exchange ActiveSync accounts, see the Sync and Email chapters to learn how to set up these accounts.

After setting up an account, you will be taken back to the Set up accounts screen so you can set up more accounts. When you are done setting up your accounts, tap **Next**.

7. On the Set up social networks screen, choose the type of social network account such as Facebook (for HTC Sense) and Twitter that you want to access from your phone. Follow the onscreen instructions to log in to your social network account. Tap **Skip** to set up social network accounts at a later time. See the Social chapter for more information about Facebook for HTC Sense.

When you are done setting up your accounts, tap **Next** on the Set up social networks screen.

## Sleep mode

Sleep mode suspends your phone to a low power state while the display is off in order to save battery power. You will still be able to receive messages and calls while the phone is in Sleep mode.



For information on how to adjust the time before the screen turns off, see “Adjusting the time before the screen turns off” in the Settings chapter.

### Switching to Sleep mode

Briefly press the POWER button to turn off the display temporarily and switch your phone to Sleep mode. Your phone also automatically goes into Sleep mode when you leave the phone idle after a certain period of time. Switching to Sleep mode also prevents accidental button or touch screen presses when the phone is in your bag or pocket.

### Waking up from Sleep mode

Your phone wakes up automatically when you have an incoming call. To wake up your phone manually, press the POWER button. You will then see that the phone has locked the screen. To find out how to unlock the screen, see “Unlocking the screen.”

## Unlocking the screen

Press the bar on the lock screen and then slide your finger down to unlock the screen or to answer an incoming call.



You can also press MENU while on the lock screen to unlock the screen.



If you have set up a screen unlock pattern, you will be prompted to draw the pattern on the screen before it unlocks. For more information on how to create and enable the screen unlock pattern, see “Protecting your phone with a screen lock” in the Security chapter.

## Home screen

The Home screen provides you with a weather clock that shows the time and weather of your current location. Tap the respective item to open the associated application.

The Home screen also lets you add the items you want and need on the Home screen. Add items like application icons, shortcuts, folders, and widgets to give you instant access to information and applications. To learn how to personalize your Home screen, see the Personalizing chapter.

### Extended Home screen

The Home screen extends beyond the screen width to provide more space for adding icons, widgets, and more. There are 6 “additional” screens apart from the main Home screen.



You cannot add more screens.

### Navigating the Home screen

You can go to the extended Home screen by sliding your finger horizontally across the screen to go to the left or right side of the Home screen. While on an extended Home screen, press HOME  to return to the main Home screen.

#### Directly going to a particular screen using Leap view

1. On any Home screen, pinch the screen to show the Leap view that shows the screens as thumbnails.



On the main Home screen, you can press HOME  to show the Leap view.

2. Tap the screen you want to open.



























# Phone status and notifications

---

## Phone status icons

These are the icons that may appear on the phone status area of the status bar:

	    6:22 PM
	EVDO available
	1xRTT available
	EVDO in use
	1xRTT in use
	Connected to a Wi-Fi network
	Bluetooth is on
	Connected to a Bluetooth device
	Airplane mode
	Alarm is set
	Speakerphone on
	Data synchronizing
	Signal strength
	Roaming
	No signal
	Vibrate mode
	Location setting on
	Location setting off
	Phone speaker is mute
	Phone microphone is mute
	Battery is very low (10% remaining)
	Battery is low (20% remaining)
	Battery is full
	Battery is charging
	Wired microphone headset connected
	Wired headset connected

## Notification icons

These are the icons that may appear on the notifications area of the status bar:



	New Gmail/Google Mail message
	New Microsoft Exchange ActiveSync or POP3/IMAP email
	New SMS/MMS
	Problem with SMS/MMS delivery
	New Google Talk instant message
	New voicemail
	Upcoming event
	Song is playing
	General notification (for example, Phone connected to computer via USB cable.)
	Storage card is low on free space
	Wi-Fi is on and wireless networks are available
	Data synchronizing or connected to HTC Sync
	New tweet
	FM Radio application in use
	More (not displayed) notifications
	Call in progress
	Missed call
	Call on hold
	Call forwarding on
	Compass needs orientation
	Uploading data (animated)
	Downloading data (animated)
	Waiting to upload
	Downloaded Android Market application installed successfully
	Update available for an application downloaded from Android Market
	Storage card is safe to remove or storage card is being prepared
	No storage card installed on the phone

## Checking notifications

Notification icons on the status bar report the arrival of new messages, calendar events, alarms set and ongoing settings such as when call forwarding is on or the current call status. You can open the Notifications panel to open the message, reminder, or event notification and see the mobile operator name.

### Opening the Notifications panel

When a new notification icon displays in the status bar, press and hold the status bar, then slide your finger downward to open the Notifications panel.



If you have several notifications, you can scroll down the screen to view more notifications.



You can also open the Notifications panel on the Home screen by pressing MENU and then tapping Notifications.

### Closing the Notifications panel

Do one of the following:



- Press and hold the bottom bar of the Notifications panel, then slide your finger up the screen.
- Press BACK ←.

## Adjusting the volume

---

Adjusting the ringer volume changes the volume level of the phone ringtone, whereas adjusting the media volume changes the volume level of sound notifications, music or video playback. The ringer volume and media volume can be separately adjusted.

### Adjusting the ringer volume

1. Press the VOLUME UP or VOLUME DOWN buttons on the left panel of the phone to adjust the ringer volume to your desired level. The Ringer volume window appears on the screen to display the volume levels. While in the lowest ringer volume level (Silent mode), press VOLUME DOWN once to set your phone to Vibrate mode. The phone vibrates and the vibrate mode icon (  ) appears on the status bar.
2. While in Vibrate mode, press VOLUME UP once to switch to silent mode. The speaker mute icon (  ) displays on the status bar.



To quickly switch your phone to silent mode, press and hold the POWER button, and then tap **Silent mode** on the options menu.

### Adjusting the media volume

When playing music or watching video, press the VOLUME UP or VOLUME DOWN buttons on the left panel of the phone to adjust the media volume. The Music/video volume window appears on the screen to display the volume level.

You can also adjust the media volume on the Settings screen.

1. Press HOME  > MENU, and then tap **Settings > Sound & display > Media volume**.
2. When the Media volume window appears, drag the slider to the left to lower the volume or to the right to increase the volume.
3. Tap **OK** to close the window.

## Connecting your phone to a computer

---

Whenever you connect your phone to a computer using the USB cable, the Connect to PC dialog box displays and prompts you to choose the type of USB connection. Select one of the following choices, and then tap **Done**:

### Charge only

Select this mode if you only want to charge the phone's battery using your computer.

### HTC Sync

When selected, the phone automatically uses HTC Sync when connected to your computer and lets you synchronize Outlook and Windows Address Book (Outlook Express), contacts and calendar events between your computer and your phone. For more information, see "Using HTC Sync" in the Accounts and sync chapter.

### Disk drive

This mode is available only when you have installed a microSD card on your phone. Select this mode when you want to use your storage card as a USB thumb drive, and copy files between your phone's storage card and your computer.

When Disk Drive mode is enabled while your phone is connected to the computer, you will not be able to run applications that use the storage card, such as Music or Photos. For more information, see "Copying files to and from the storage card" in this chapter.

### Mobile Broadband Connect

When you do not have Internet connection on your computer, you can select this mode to share your phone's mobile data connection with your computer. For more information, see "Using Your Phone as a Modem" in the Internet chapter.



If you do not want to show the Connect to PC dialog box everytime you connect the phone to the computer, select the **Don't ask me again** checkbox in the Connect to PC dialog box. The default connection type will be used when you connect the phone to the computer.

To check or change the default connection type and to show or hide the Connect to PC dialog box, press HOME  > MENU, and then tap **Settings** > **Connect to PC**.

## Copying files to and from the storage card

---

1. Connect the phone to your computer using the supplied USB cable.
2. When the Connect to PC dialog box appears, tap **Disk drive**, and then tap **Done**.
3. On your computer, the connected phone is recognized as a removable disk. Navigate to this removable disk and open it.
4. Do one of the following:
  - Copy the files from the computer to the phone's storage card's root folder.
  - Copy the files from the phone's storage card to a folder in your computer or computer desktop.
5. After copying the files, unmount the removable disk (that is, the connected phone) as required by your computer's operating system to safely remove your phone.
6. Do one of the following:
  - Disconnect the phone from the computer.
  - If you want to keep the phone connected to the computer but want the phone to be able to access the storage card, open the Notifications panel, tap **Disk drive**, select an option except **Disk drive**, and then tap **Done**. See "Opening the Notifications panel" in this chapter to learn how to open the Notifications panel.

## Searching your phone and the Web

---

You can search for information on your phone and on the Web by using the **Quick Search Box**. Some applications, such as People or Mail, have their own search box, which you can use to search within those applications (the application's icon is at the left of the search box.)

### Setting Web and Quick Search Box options

1. Press HOME  > MENU, and then tap **Settings**.
2. Scroll down the screen, and then tap **Search**.
3. Tap **Google search settings**, and then do the following:
  - Select **Show web suggestions** if you want to include suggestions from Google when doing a search.
  - Select **Search history** to enable personalized search history. You need to sign in to your Google Account to use this feature. The **Show web suggestion** check box needs to be selected for this option to be enabled.

Press BACK  when you are done.

4. Tap **Searchable items**, and then select the items you want included when doing a search.

### Searching the Web and your phone using the Quick Search Box

1. Press HOME  > SEARCH .



If you are in an application such as Mail, press the SEARCH  button to toggle between doing a search in the application only and searching your phone and the Web.

2. Enter the search item in the Quick Search Box. As you type, matching items on your phone and suggestions from Google web search are shown as a list.



The suggested items that appear will depend on the options that you have selected in the search settings. See “Setting Web and Quick Search Box options” for details.

3. Do one of the following:
  - If what you're searching for is in the list of suggestions, tap it in the list. The item opens in the appropriate application.
  - If what you're searching for is not in the list, tap  to search the Web. The web browser opens, displaying results of a Google search on the Web.

# Personalizing

## Making your phone truly yours

---

Make your phone look and sound just the way you want it. Personalize your phone with a different wallpaper, ringtone, and notification sound for events such as incoming text, email, calendar reminders, and more.

Your phone's Home screen is highly customizable and extends beyond the screen width, giving you plenty of space to add the information that matters most in your daily life and phone features that make communication quicker and easier. You have up to seven screens that extend to the left and right sides of your display as your Home screen, on which you can add elements such as widgets, program icons, shortcuts to information, and more.



To find out how to set notification sounds for events, see “Changing sound settings”.

## Changing the ringtone

---

Choose from the available selections of ringtones on your phone.

1. Press HOME  > MENU, and then tap **Settings**.
2. Tap **Personalize > Default ringtone**. The Phone ringtone selection menu then opens.
3. Scroll through the available ringtones and tap the ringtone you want to use. The ringtone briefly plays when selected.
4. Tap OK.

You can also download or copy ringtones or songs to your phone's storage card. To find out how you can copy files to your storage card, see “Copying files to and from the storage card”.

Ringtones or songs downloaded or copied to your storage card are not automatically added to the ringtone selection menu. You need to go to the Music application and set a ringtone or song in your storage card as your ringtone. To find out how to set a ringtone using the Music application, see “Setting a song as ringtone” in the Music chapter.



See “Specifications” for a list of audio file formats supported by your phone.



## Personalizing your phone with scenes

Your phone becomes multiple phones in one when you use scenes. Scenes are personalized Home screen layouts that you can quickly apply to your phone. By switching between scenes, you instantly turn your phone into your perfect weekend phone, travel phone, work phone, or pure play phone.

### Using a preset scene

Your phone features preset scenes, each preconfigured with a different wallpaper and collection of widgets that reflect different moments in your life. You can choose a scene that is suitable for work, play, travel, or your social life.

1. Press HOME  > MENU, and then tap **Scenes**.
2. In the Choose a scene menu, select a preset scene and then tap **Done**.



Verizon (default)

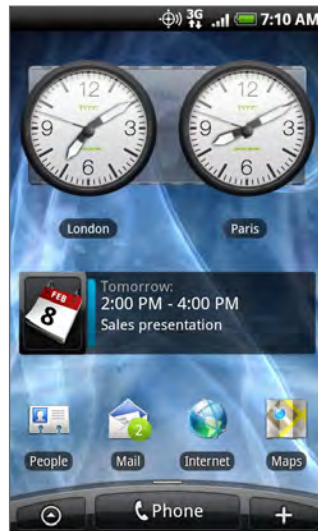



Work



Play

### Customizing and saving a scene

After selecting a preset scene, you can add widgets and other elements, arrange the layout, change the wallpaper, and save the whole Home screen as your personalized scene.

1. Press HOME  > MENU, and then tap **Scenes**.
2. In the Choose a scene menu, select a preset scene that already has some widgets, or select **Clean Slate** if you want to design your own Home screen.
3. Add widgets and other elements that you want.
4. Arrange the layout of your Home screen according to your preference.
5. Change the Home screen wallpaper. You can also change the lock screen wallpaper.
6. When you are done designing your Home screen, press HOME  > MENU and then tap **Scenes** again.
7. Under **My scenes**, make sure the **Current (unsaved)** option is selected and then tap **Save**.
8. Enter a new scene name for your Home screen and then tap **Done**. Or, if you already created a scene, enter the same scene name, tap **Done** and then tap **Replace**.

## Renaming or deleting a scene

You can rename or delete a personalized scene that you created. Preset scenes cannot be renamed or deleted.

1. Press HOME  > MENU and then tap **Settings** > **Personalize** > **Scenes**.
2. Under **My scenes**, press and hold a scene and choose whether to rename or delete it.

## Changing your wallpaper

---

Personalizing your Home screen wallpaper with your favorite photo is a quick and easy way to change the feel of your phone and give it a fresh look. Browse the collection of wallpapers included in your phone or choose from photos that you have taken with the camera. You can also change your Home screen to use an animated wallpaper.

The wallpaper that you choose for the Home screen will also be used as the lock screen wallpaper.



1. Press HOME  > MENU, and then tap **Wallpaper**.
2. Do one of the following:
  - Tap **Live wallpapers** to choose from preset animated wallpapers.
  - Tap **My photos** to select a photo that you have taken using the camera or copied to your storage card. Crop the photo and then tap **Save**.
  - Choose from preset wallpapers.
3. After changing the wallpaper, remember to save it to the scene that you created or save it as a new scene. To find out how to save a scene, see “Customizing and saving a scene”.

## Personalizing your Home screen with widgets

Widgets put at-a-glance important information and media content up front on your Home screen. Some widgets are already added to your Home screen for your convenience. You can add more from the available selections of widgets, or download more widgets.

### Adding a widget to your Home screen

A wide selection of widgets is available for you to choose from, such as Calendar, Music, Photo Album, Friend Stream, Twitter, and more.



1. Press HOME . Go to the part of the Home screen where there's space to add a new widget. To find out how, see "Navigating the Home screen" in the Basics chapter.
2. Tap  or press and hold on the Home screen to open the Add to Home options menu.
3. Tap **Widget** and then select a widget that you want.
4. Most HTC widgets are available in a variety of designs and sizes to suit your needs. Tap the right or left arrow button at the bottom of the screen to view the different styles, and then tap **Select** to choose one.



You can also add widgets that allow you to quickly switch on or off certain settings of your phone, such as Wi-Fi, Mobile Network, Bluetooth, and more. Scroll down the widgets list, tap **Settings**, and then tap the widget that you want.

### Downloading HTC widgets

A selection of fun and useful HTC widgets are also available for download.

1. Press HOME . Go to the part of the Home screen where there's space to add a new widget. To find out how, see "Navigating the Home screen" in the Basics chapter.
2. Tap  or press and hold on the Home screen to open the Add to Home options menu.
3. Tap **Widget** and then tap **Get more HTC widgets**.
4. Tap to select a widget.
5. Tap **Details** to see a short description about the widget. After reading, press BACK .
6. When you're ready to download and add the widget to your Home screen, tap **Download**.



## Adding application icons and other shortcuts on your Home screen

---



Place application icons on your Home screen to open applications quicker. You can also add shortcuts to settings and specific information such as a bookmarked webpage, someone's phone number, a music playlist, route directions, and many other items, to your Home screen.

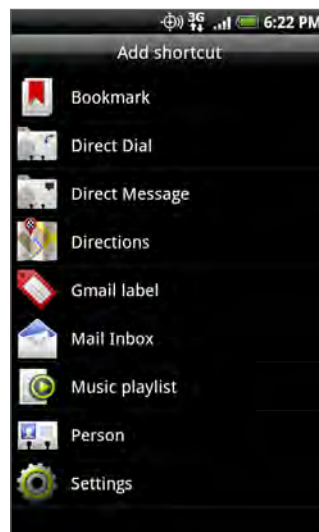

The shortcuts available depend on the applications that are installed on your phone.

1. Press HOME . Go to the part of the Home screen where there's space to add a new shortcut. To find out how, see "Navigating the Home screen" in the Basics chapter.
2. Tap  or press and hold on the Home screen to open the Add to Home options menu.
3. Do one of the following:
  - To add an application icon, tap **Program** and then select an application.
  - To add a shortcut to a setting or information, tap **Shortcut** and then select the type of information or setting.



To add an application icon on the Home screen, you can also press HOME , tap , and then press and hold an application icon. Without lifting your finger, drag the icon to an empty area on the Home screen, and then release it.

## Adding folders on your Home screen

Use folders to group related applications and other shortcuts to keep your Home screen tidy and organized.



You can also add information folders that show up-to-date information such as Bluetooth received files, your Facebook phonebook, and more.

### Creating a new folder and adding items to it

1. Press HOME . Go to the part of the Home screen where there's space to add a new folder. To find out how, see "Navigating the Home screen" in the Basics chapter.
2. Tap or press and hold on the Home screen to open the Add to Home options menu.
3. Tap Folder and then tap New Folder.
4. Press and hold an application icon or a shortcut that you want to move to the folder. The phone then vibrates. Don't lift your finger.
5. Drag the application icon or shortcut and drop it on top of the folder.



Simply tap the folder to open it so you can access the applications and shortcuts inside the folder.

### Renaming a folder

1. Tap the folder to open it.
2. Press and hold the folder window's title bar.
3. Enter a new folder name and then tap OK.

# Rearranging or removing widgets and icons on your Home screen

---

Rearrange the widgets and icons on your Home screen to give room for adding more items to the Home screen. You can also remove widgets and icons that you don't frequently use.

## Moving a widget or icon

1. Press and hold the widget or icon you want to move.

The phone vibrates and you'll see a green box around the widget or icon. Don't release your finger.

2. Drag the widget or icon to a new location on the screen.

Pause at the left or right edge of the screen to drag the widget or icon onto another Home screen panel.

3. When the widget or icon is where you want it, release your finger.

If you've released your finger but a message shows that there's no space to place the widget or icon, drag it right or left again to another Home screen panel.

## Removing a widget or icon

1. Press and hold the widget or icon you want to remove.

The phone vibrates and you'll see a green box around the widget or icon. Don't release your finger.

2. Drag the widget or icon to the **Phone** button. The **Phone** button then changes into the **Remove** button and turns red.

3. When the widget or icon also turns red, release your finger.

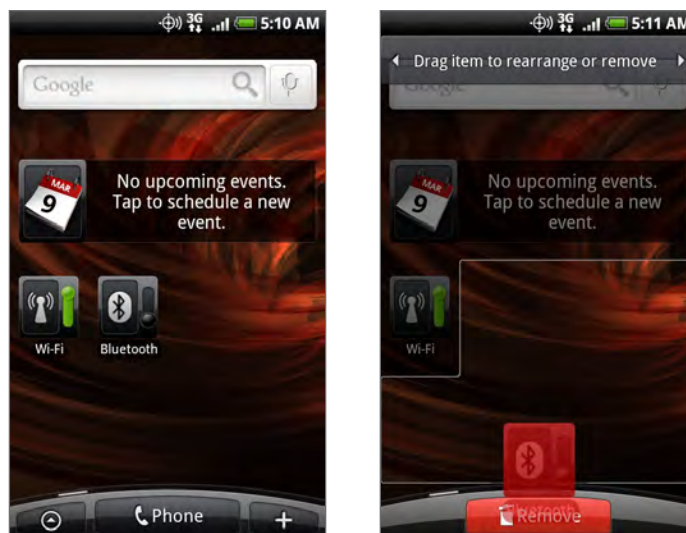

# Phone calls







## Making calls

---

There are several convenient methods to make a call from your phone.

### Calling somebody using your phone



You can either dial a number directly, or you can use the Smart Dial (see Smart Dial) feature to search and call a contact in your contacts list or a number from call history.

1. Press HOME , and then tap .
2. Begin entering the first few digits or characters by tapping the keys on the phone keypad. As you enter digits or letters, the panel displays numbers and names that match the keys you tapped.  
  
If you enter a wrong digit, tap  to erase that digit. To erase the entire number, press and hold .
3. Tap  to close the phone keypad and to see if there are more matching numbers or contacts. To browse through the filtered list, flick through the list or slide your finger up or down the list slowly.
4. To place a call, do one of the following:
  - If there are no matching contacts in the list, after entering the number, tap **Call**.
  - Tap the phone number or contact from the list.
  - To call a different phone number associated with the contact, tap  at the right side of the contact name. On the contact details screen, tap the number you want to call.

### Smart Dial



The phone dialer's Smart Dial feature makes it quick and easy for you to place a call. Simply enter the phone number or first few letters of the person you want to call. Smart Dial automatically searches and filters your contacts list stored on your phone, and the phone numbers from the call history.

### Calling a speed dial number

1. Press HOME , and then tap .
2. On the phone keypad, press and hold the number that is associated with the contact you want to call.



The number 1 on the phone keypad is generally reserved for your voicemail. Press and hold this button to call voicemail and retrieve your voicemail messages.

### Adding a contact to speed dial

1. Press HOME , and then tap .
2. Press MENU, and then tap **Speed dial > Add new**.
3. Enter the name of the contact you want to add. When the name comes up in the list, tap the name.
4. On the Speed dial screen, select the phone number of the contact to use, and the phone keypad assignment. Tap **Save**.



## Calling using Voice Dialer

1. Press HOME , and then tap  > Voice Dialer.
2. When the Voice Dialer message box appears and you see “Listening” on the screen, say “Call [name of person]” in a clear voice into the phone.



The person you want to call should be in your People list.

3. A confirmation message will pop up asking if the person to call is correct. Tap **OK** if the person is correct or tap **Cancel** to try again.



- If the contact has more than one number, or if the Voice Dialer does not detect your voice accurately, the confirmation message displays a list of the contact’s phone numbers or suggested results.
- You can also use voice Dialer to open programs.

## Calling a phone number in a text message

1. Press HOME , tap **Messages**, and then tap the message with the phone number.
2. In the message thread, tap the message with the phone number.
3. On the **Select link** screen, tap the number you want to call.
4. Edit the phone number if needed, and then tap **Call**.



To call the message sender, in the All messages list, press and hold the message, and then tap **Call** on the options menu.

For more information about text messages, see the Messages chapter.

## Calling a phone number in an email

1. Press HOME , and then tap **Mail**.
2. Open the email account where the email with the number is located.
3. In the email account’s inbox, tap the email to open it.
4. In the email body, tap the phone number. The phone dialer screen opens with the phone number already entered.

The phone will recognize a number as a phone number if the number has a minimum of 5 digits and have at least one of the following:

- Numbers preceded by a “+” in front. For example, +1-987-654-321 or +1987654321.
- Numbers enclosed in parenthesis in front. For example, (02)987654321 or (02)987-654-321.
- Numbers separated by dashes. For example, (02)-987-654-321 or 0987-654-321.

5. Tap **Call**.

For more information about email, see the Email chapter.

## Making an emergency call

On the phone dialer screen, dial the international emergency number for your locale (for example, 000), and then tap **Call**.



Your phone can only operate when in a CDMA service area.

## Using Assisted Dialing

Assisted Dialing allows you to easily dial international calls while roaming in another country.

### Turning Assisted Dialing on

1. Press HOME  > MENU, and then tap **Settings > Call > Assisted Dialing**.
2. Select the **Enable Assisted Dialing** check box.
3. Under Reference Country, select the country that you want to call.

### Editing a country's international call settings

1. Press HOME  > MENU, and then tap **Settings > Call > Assisted Dialing**.
2. Under Reference Country, select the country whose settings you want to edit.
3. Press MENU and then tap Edit.
4. Edit the Country Code, IDD Prefix (International Direct Dial), NDD Prefix (National Direct Dial), Area/City Code and National Number Length (length of phone number).
5. Tap Save.

To reset the Reference Country to the default

1. Press HOME  > MENU, and then tap **Settings > Call > Assisted Dialing**.
2. Under Reference Country, select the country whose settings you want to set to default values.
3. Press MENU and then tap Set Default.

## Receiving calls

When you receive a phone call from a contact, the Incoming call screen appears and displays the caller ID icon, name, and phone number of the calling party. When you receive a phone call from someone who is not stored in People, only the default caller ID icon and phone number appear on the Incoming call screen.

### Answering an incoming call

Depending if the display is on or off, you need to:

- If the display is on, tap **Answer**.
- If the display is off, the display will turn on showing the Lock screen. Drag the bar down to answer the call.

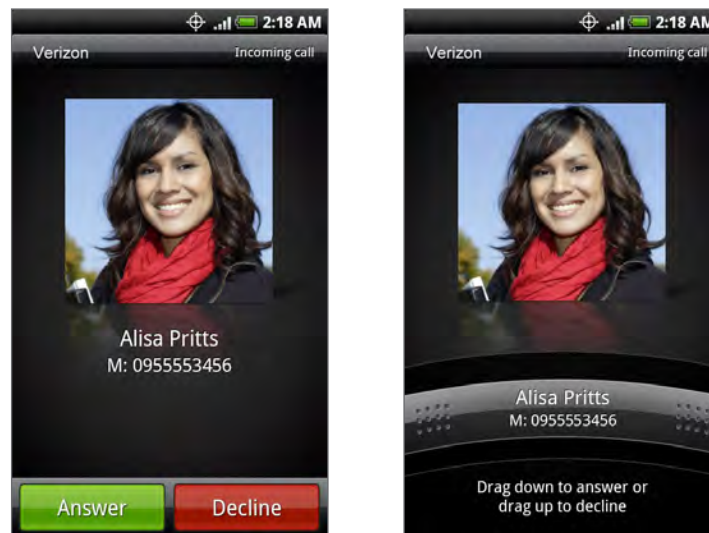

### Muting the ringing sound without rejecting the call

Do one of the following:



- Press the VOLUME DOWN button.
- Place the phone face down on a leveled surface.



If the phone is already facing down, the phone will still ring when there are subsequent incoming calls.

### Automatically scaling down the ring volume when picking up the phone

You can set your phone to automatically scale down the ring volume when you pick up the phone to answer calls.

1. Press HOME  > MENU, and then tap **Settings > Sound & display**.
2. Scroll down the screen, and then select the **Quiet ring on pickup** check box.
3. Press BACK .

## Rejecting an incoming call

Depending upon if the display is on or off, you need to::

- If the display is on, tap **Decline** to reject and send the call to your voicemail.
- If the display is off, the display will turn on showing the Lock screen. While the Lock screen is showing, drag the bar up to reject and send the call to your voicemail.
- If the display is off, the display will turn on showing the Lock screen. While the Lock screen is showing, press MENU, and then tap **Decline** to reject and send the call to your voicemail.



## Rejecting a call and sending a text message

You can automatically send a default text message to the caller and reject the incoming call.

To reject and send a message when you receive an incoming call, press MENU, and then tap **Send message**.

### Editing the default message

You can change the message that is sent out.

1. Press HOME , and then tap .
2. Press MENU, and then tap  settings > Edit default message.
3. Enter the new message, and then tap OK.

## Using in-call options

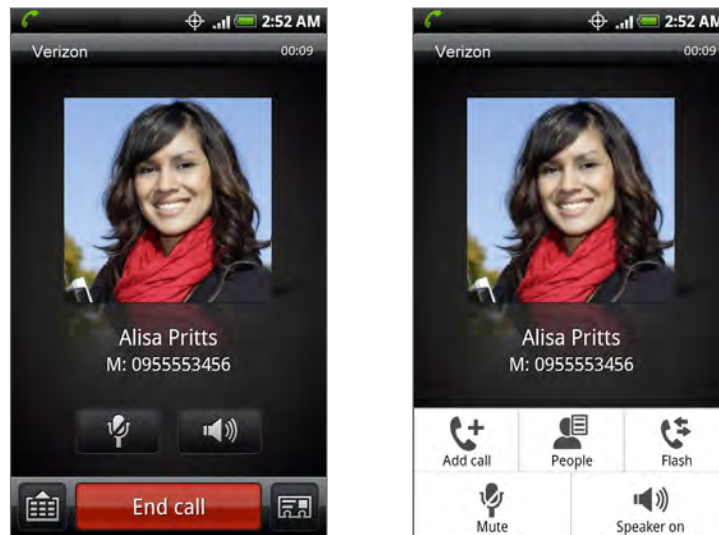

When a call is in progress, use the buttons onscreen to mute or unmute the microphone or to turn the speakerphone on or off. You can also press MENU to open the call options to let you add a call, place the call on hold, mute the microphone, and more.

### Handling multiple calls

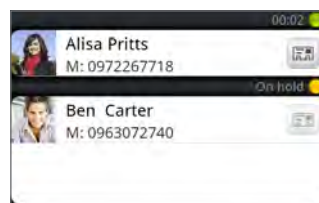

Your phone notifies you when you have another incoming call, and gives you the option of rejecting or accepting the call. If you are already on a call and accept the new call, you can choose to switch between the two callers.

1. When you receive another call, tap **Answer** to accept the second call, and to put the first call on hold.
2. To switch between callers, tap the person you want to talk to on the screen.



4. To end the current call and return to the other call, tap **End call**.

### Setting up a conference call

1. Make a call to the first participant.
2. When connected, press MENU, tap **Add call**, dial the number of the second participant, and then tap **Call**. The first participant is put on hold when you dial the second participant.
3. When connected to the second participant, tap  (merge).
4. To add another participant to the conference call, tap , and then dial the number of the contact you want to invite to the conference call.





The conference call is put on hold when you call another contact. When you are connected to the other contact, you can talk to that party in private.

5. When connected, tap  to add the participant to the conference call.
6. When finished, tap **End call**.





Not all mobile networks support conference calling. Contact Verizon Wireless for details.

## Muting the microphone during a call

On the screen, tap  to toggle between turning the microphone on or off. When the microphone is turned off, the Mute icon (  ) appears in the status bar.

## Turning the speakerphone on or off during a call

On the screen, tap  to toggle between turning the speakerphone on or off. The Speakerphone icon (  ) appears in the status bar when the speakerphone is on.



To avoid damage to your hearing, do not hold your phone against your ear when the speakerphone is turned on.

## Ending a call

On the screen, tap **End call**.





If the phone display is off, press **POWER** to turn on the screen so you can tap **End call**.

If the phone number of the person who called is not in your contacts list, you can choose to save the number to your contacts list after you hang up.

## Using call history

When you miss a call, the missed call icon (  ) appears in the title bar. Use the **Call history** tab in the People application to check who the caller was or view all your dialed numbers and received calls.

1. Press HOME , and then tap .
2. Tap  at the bottom-right corner of the screen.
3. Do one of the following:
  - Tap the name or number in the list to call.

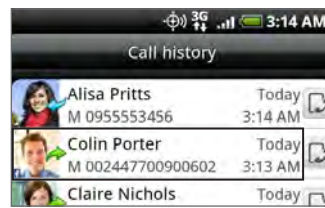

- Press and hold a name or number in the list to display the options menu where you can select to view the contact information (if the number is stored in your contacts list), edit the number before you redial, send a text message, or delete from call history.

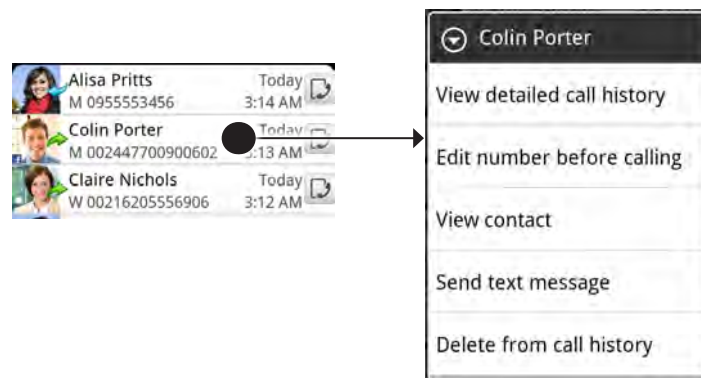



- Tap  to show the call history for that particular contact.



You can also access call history from the People application. See the People chapter for more information.

## Adding a new phone number to your contacts from call history





1. Press HOME , and then tap .
2. Tap  at the bottom-right corner of the screen.
3. Press and hold the received call or number that is not in your contacts list that you want to save to your contacts list, and then tap **Save to contacts**.
4. In the blank contact record that appears, enter the contact name and other information. The phone number is automatically added to the **Mobile** field in the Phone section. To store it as another type of number, for example a home number, tap the **Mobile** button.
5. Scroll down the screen and tap **Save**.



To learn how to add new contacts or edit the contact information, see the People chapter.

## Checking a missed call



You will see the missed call icon  in the status bar when you miss a call.

1. Press HOME , and then tap .
2. Tap  at the bottom-right corner of the screen.
3. In the call history list, missed calls are indicated by the missed call icon (  ).



You can also press and hold the status bar, and then slide your finger downward on the screen to open the Notifications panel. The missed call number or contact name is displayed.

## Clearing the call history list

1. Press HOME , and then tap .
2. Tap  at the bottom-right corner of the screen.
3. Do one of the following:
  - To remove one name or number from the list, press and hold the name or number, and then tap **Delete from call history**.
  - To clear the entire list, press MENU, and then tap **Delete all**.



# Call services

---

Your phone can directly link to the mobile phone network, and enable you to access and change the settings of various phone services for your phone. Call services may include call forwarding, call waiting, voicemail, and more. Contact Verizon Wireless to find out about the availability of call services for your phone.

To open call services, press HOME  > MENU, and then tap **Settings > Call**.

## Voicemail service

Shows the current voicemail service being used.

## Voicemail settings

Specify voicemail number.

## Clear voicemail notification

If you have a notification of a new voicemail, you can clear the notification with this option.

## Auto Retry

When enabled, the phone automatically redials a number when the attempted call fails.

## TTY mode

Allow the use of a TTY (teletypewriter) device for users who are visually or hearing impaired.

## Hearing aids

Turn on the Hearing Aid Compliance feature that reduces interference to hearing aids.

## Phone settings

Edit the call reject message, choose whether to open the message editor when you reject a call with a message, and choose whether to allow automatic saving of an unknown contact number when a call with that number ends.

## NBPCD

Set the calling parameters for the current country, such as country code and IDD prefix.

## Assisted Dialing

Assisted Dialing allows you to easily dial international calls while roaming in another country. See “Using Assisted Dialing” in this chapter for details.

## Voice Privacy

Encrypts outgoing voice calls and uses secure channels when available.

## Visual Voice Mail



---

Visual Voice Mail allows the management of voice mail directly from the phone rather than accessing your voice mail via traditional methods. Visual Voice Mail displays a list of messages and allows the user to choose which message to listen to or erase, without having to dial into their mailbox, listen to voice instructions, or listen to prior messages.

### Setting up Visual Voice Mail



You must be a Verizon Wireless subscriber before continuing.

1. Press HOME , and then tap  > Voice Mail > Visual Voice Mail.
2. When prompted, enter your basic voice mail password.
3. Read the terms of use statement and then tap **Subscribe** to continue.
4. Tap **Exit** and wait 5 minutes before using Visual Voice Mail.

### Using Visual Voice Mail

1. Press HOME , and then tap  > Voice Mail.

The first time you run Visual Voice Mail after setting it up, you are prompted to read the terms of use statement.

2. After reading the terms of use statement, scroll down and tap **Accept** to continue.
3. On the Voicemail screen, you can:
  - Tap **Compose voicemail** to record and send a voice mail.
  - View a list of received Visual Voice Mail messages.
  - Tap **Menu** and sort and delete voice mails, call your voice mail box, configure voice mail settings, and more. You can also synch with the Visual Voice Mail server to refresh the Visual Voice Mail list.





Visual Voice Mail is only available in the National Enhanced Services Coverage Area and only on select devices. Specific terms, conditions and monthly charges apply. Basic Voice Mail and V CAST Coverage Area are required and V Block must be removed to use Visual Voice Mail.

Anyone in possession of this device can access voice mail. To limit unauthorized access to voice mail, consider locking the phone when not in use.

## Turning Airplane mode on or off

---

In many countries, you are required by law to turn off the phone while on board an aircraft. A way to turn off the phone function is to switch your phone to **Airplane mode**. When you enable Airplane mode, all wireless radios on your phone are turned off, including the call function, data services, Bluetooth, and Wi-Fi.

1. Press HOME  > MENU, and then tap **Settings > Wireless & networks**.
2. Select or clear the **Airplane mode** check box to enable or disable Airplane mode. When enabled, the Airplane mode icon (  ) is displayed in the status bar.



When you disable Airplane mode, the call function is turned back on and the previous state of Bluetooth and Wi-Fi is restored.

# People

## About People

---

In **People**, you can easily manage your communications with contacts via phone, messaging, and email. You can also view updates on their Facebook and Flickr accounts.

If you are synchronizing contacts with your Google account, with your PC, and/or with an Exchange Server, any contacts stored in those accounts are displayed in People. You can also synchronize contacts from your Facebook account in People. For more information on synchronizing accounts, see “Ways of getting contacts into your phone” in this chapter.

## Ways of getting contacts into your phone

---

You can add contacts to your phone from:

- **Gmail/Google Mail contacts** Gmail/Google Mail contacts are imported to your phone after you set up a Google Account. For details, see the “Gmail/Google Mail” in the Email chapter.
- **Phone contacts** See “Adding a new contact” in this chapter for details.
- **Exchange ActiveSync Server** See “Synchronizing with a Microsoft Exchange ActiveSync account” in the Accounts and sync chapter for details.
- **Contacts on your computer** See “Using HTC Sync” in the Accounts and sync chapter for details.
- **Facebook** See “Adding an account” in the Accounts and sync chapter for details.

## People screen

The People screen gives you easy access to all your contacts, as well as even faster access to the people and groups of people you contact most often.

The People screen has the following tabs:

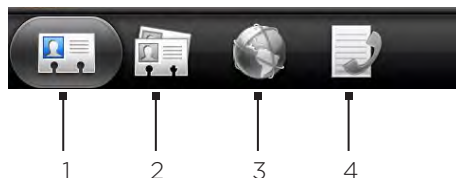

---

### 1 All tab

Gives you access to all contacts on your phone, including Google contacts, Exchange ActiveSync contacts, Phone contacts, and Facebook contacts. You can also use this tab to open or update My contact card. For more information, see “Setting up My Contact Card” in this chapter.

---

### 2 Groups tab

Lets you assign contacts to groups so you can easily send an SMS, MMS, or email message to a whole group. For more information, see “Contact groups” in this chapter.

---

### 3 Online directories tab

Search for contacts on your online directories such as your Exchange ActiveSync or Facebook account to copy to your phone.

---



### 4 Call history tab

Lists all your dialed numbers and received and missed calls. See “Using Call History” in the Phone calls chapter.

---

## Setting up My contact card

My contact card provides a convenient way to store your personal contact information so that you can easily send it via SMS, MMS, email, or Bluetooth.

1. Press HOME , and then tap  > People.
2. On the All tab of the People screen, tap Me, and then tap Tap here to edit contact.



If you are logged in to your Facebook account through Facebook for HTC Sense, instead of Me, you will see your the name you use in Facebook.

3. Enter your name and contact details.
4. Tap Save.

## Your contacts list

The All tab of the People screen shows all your contacts, including Google contacts, Exchange ActiveSync contacts, Phone contacts, and Facebook contacts.



If you signed in to your Google Account and Facebook account when you first set up the phone, your contacts from those accounts will appear in the contacts list when you open People.

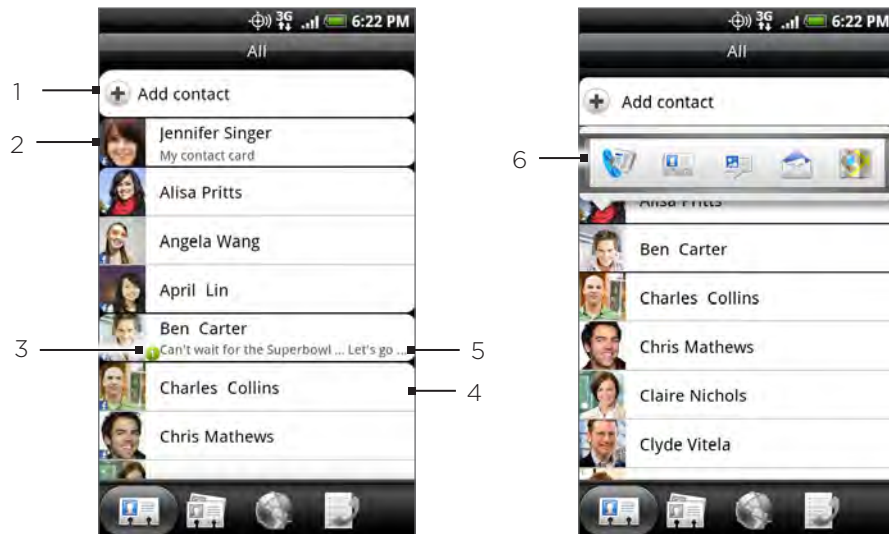

- 
- 1 Create a new contact.

---

  - 2 Tap to edit your My contact card.

---

  - 3 This icon appears when the contact:
    - Has sent you a new text or email message, or tried to call you but you missed the call.
    - Has updated his or her Facebook profile or has added photos on Flickr or Facebook.
    - Has upcoming Facebook events.

---

  - 4 Tap to open the contact details screen for that contact.

---

  - 5 This appears when the contact is a Facebook contact or you link the contact to his or her Facebook account.

---



  - 6 Tap the photo or icon to open a menu where you can quickly choose how to communicate with the contact. Depending on the contact information stored, you can call, send a message or email, see the contact's Facebook profile, and map his/her address in Google Maps.

---





To view only contacts of a particular type, for example Google contacts or Facebook contacts, press MENU, tap **View**, and select the contact types.

## Adding a new contact

1. Press HOME , and then tap  > **People**.
2. On the **All** tab, tap **Add contact** at the top of the screen.
3. Select the **Contact type**, for example **Google** or **Microsoft Exchange ActiveSync**. This determines which account the contact will sync with. For more information, see “Ways of getting contacts into your phone” in this chapter.
4. Tap the **Name** field, enter the first and last name of the contact, and choose the order in which to display the names. Tap **OK**.
5. Enter the contact information in the fields provided.
6. Scroll to the bottom of the screen, and then tap **Save**.

## Importing contacts from an Exchange ActiveSync account

Access contacts from your Exchange ActiveSync account, and then copy them to the phone. You need to have your Exchange ActiveSync account set up on your phone.





1. Press HOME , and then tap  > People.
2. On the Online directories tab, tap Company directory.
3. Enter the name, and then tap .
4. In the list, tap the name of the contact you want to copy to your phone.
5. Tap Save to People.

## Merging contact information





Merge duplicated contacts on your phone to avoid clutter and confusion. If you have the same contact appear in your Phone, Google, and Facebook accounts, you can merge the contact information into one contact.

The phone automatically merges contacts that it finds to have similar data. If you need to manually merge contacts or break the link between contacts, follow the procedures below.



### Manually merging contact information

1. Press HOME , and then tap  > People.
2. On the All tab, tap the name of the contact (not the icon or photo) you want to merge with another contact on your phone.
3. At the upper right corner of the screen, tap  or  (if there are suggested links.)
4. On the screen, you can:
  - If there are suggested links, tap  to link the contact to the selected account.
  - Tap one of the options available in the Add contact section.
5. Tap Done.



### Breaking the contact information link between contacts

1. Press HOME , and then tap  > People.
2. On the All tab, tap the name of the contact (not the icon or photo) whose contact information link you want to break.
3. On the upper right corner of the screen, tap .
4. On the Linked contacts section, tap  beside the name of the contact to break the link.
5. Tap Done.

## Editing a contact's information

1. Press HOME , and then tap  > People.
2. On the All tab, press and hold the contact, and then tap Edit contact.
3. Enter the new information for the contact.
4. Scroll to the bottom of the screen, and then tap Save.

## Searching for a contact



1. Press HOME , and then tap  > People.
2. Press the SEARCH  button on the phone.
3. In the search bar, enter the first few letters of the first or last name of the contact you are looking for. Matching contacts are displayed.





If the list of matching contacts is long, you can view more results by tapping  to hide the onscreen keyboard.

4. Tap the contact to open his or her contact details screen. See “Contact information and conversations” in this chapter for details.

## Backing up your contacts to the storage card

1. Press HOME , and then tap  > People.
2. Press MENU, and then tap Import/Export > Export to SD card.
3. When asked to confirm, tap OK.

## Importing contacts from the storage card

1. Press HOME , and then tap  > People.
2. Press MENU, and then tap Import/Export > Import from SD card.





You can only import contacts that were exported to the storage card using the **Export to SD card** feature on the phone. See “Backing up your contacts to the storage card.”

3. If you have Google or Exchange ActiveSync accounts set up on your phone, tap the type for the imported contacts.



Press BACK  to stop importing contacts from the storage card.



## Deleting contacts

1. Press HOME , and then tap  > People.
2. On the All tab, press MENU, and then tap Delete.
3. Select the contacts you want to delete, and then tap Delete.
4. When prompted, tap OK.



To delete a single contact, on the All tab, press and hold the name of the contact (not the icon or photo) who you want to delete and select **Delete contact** from the menu.

## Sending contact information as a vCard via MMS

1. Press HOME , and then tap  > People.
2. On the All tab, press and hold the name of the contact (not the icon or photo) whose contact information you want to send, and then tap **Send contact as vCard**.
3. Select the type of information you want to send, and then tap **Send**.
4. Enter the recipient's number or email address, and then tap **Send**.







You cannot send a vCard using SMS.

You can also send a vCard via Bluetooth. To learn how to send files through Bluetooth, see the Bluetooth chapter.

## Sending your contact information as a vCard via MMS

1. Press HOME , and then tap  > People.
2. On the All tab, tap [Your name] My contact card.
3. Press MENU, and then tap **Send my contact info**.
4. Select the type of information you want to send, and then tap **Send**.
5. Enter the recipient's number or email address, and then tap **Send**.



You cannot send a vCard using SMS.



You can also send your contact vCard via Bluetooth. To learn how to send files through Bluetooth, see the Bluetooth chapter.

## Contact groups

---

On the **Groups** tab, you can assign contacts to groups so you can easily send an SMS, MMS, or email message to a whole group. You can also sync groups on your phone with the groups in your Google account, accessible via your computer's web browser.

### Creating a group and adding contacts



1. Press HOME , and then tap  > People.
2. On the **Groups** tab, at the top of the screen, tap **Add group**.
3. Enter a name for the group, and then tap **Add contact to group**.
4. Select the contacts you want to add to the group, and then tap **Save**.



If your contacts list is long, you can use the search bar to search for contacts quickly, or tap  to hide the onscreen keyboard and scroll through the list.

6. Tap  to add a group from photo.
7. Tap **Save**.



### Deleting a group

1. Press HOME , and then tap  > People.
2. On the **Groups** tab, press and hold the group you want to delete, and then tap **Delete group**.





You can only delete groups that you have created.

### Adding or removing contacts from a group

1. Press HOME , and then tap  > People.
2. On the **Groups** tab, press and hold the group, and then tap **Edit group**.
3. You can:
  - Tap the group name to change the name. You can only change the name for groups that you have created.
  - Tap the icon to the left of the group name to change or remove the group photo.
  - To add contacts to the group, tap **Add contact to group**, select the contacts you want to add, and then tap **Save**.
  - To remove a contact from the group, tap  at the right side of the contact name, and then tap **Save**.

## Sending an SMS/MMS message or email to a group

1. Press HOME , and then tap  > People.
2. On the **Groups** tab, tap the group you want to send an SMS/MMS message or email to.
3. Go to the **Group action** tab, and then do one of the following:
  - Tap **Send group message** to send an SMS/MMS message to the group. For information about composing and sending messages, see the Messages chapter.



You will be charged by your mobile provider for each message sent. For example, if you send a message to a group of five people, you will be charged for five messages.

- Tap **Send group mail** to send an email to the group. For information on composing and sending email, see the Email chapter.

## Contact information and conversations

---

When you tap a contact on the People screen, the contact details screen opens, showing you the information stored for that contact, exchanged messages and phone calls with that contact, Facebook notifications, and more.

The contact details screen has the following tabs:



---

### 1 Details tab

Shows the information you have stored for the contact, and allows you to get in touch with the contact directly by tapping any of the displayed methods. For example, if the contact has a stored work phone number, tap **Call Work** to call that number.

You can also add one of the contact's phone numbers as a speed dial number. For information, see "To add a contact to speed dial" in this chapter.

---

### 2 Messages tab

Shows your exchanged SMS messages with the contact. Tap a message to view it. To send a new message, tap **New message**. For more information about messages, see the Messages chapter.

---

### 3 Mail tab

Shows email messages you have received from the contact. Tap an email message to view it. To send a new email message, tap **New mail**. For more information about email, see the Email chapter.

---

### 4 Updates and events tab

Shows the contact's Facebook status, updates, and events, and shows when he or she uploads new photos to Flickr. When there is a notification of the contact's birthday, you can tap the notification to call the contact directly or send a message greeting.

You need to be logged in to your Facebook account to see the updates and events. If you are not logged in, tap **Link to Facebook**.

---

### 5 Photos tab

Shows the contact's Facebook and Flickr photo albums. Tap an album to look at the photos in the album.

You need to be logged in to your Facebook and Flickr accounts to see the photo albums. If you are not logged in, tap **Link to Facebook** and/or **Link to Flickr**.

---

### 6 Call history tab

Lists all your incoming, outgoing, and missed calls to and from the contact. Tap a list item to call the contact using the displayed number.

---



# People widget

---

Put the group of people you contact most right on the Home screen of your phone by adding them as the People widget. Using the People widget, you can instantly place a call, send a message, or view details of a favorite contact with a single tap.

## Adding the People widget

Slide your finger left or right on the Home screen to find the People widget. If you do not find the People widget on the Home screen, follow this procedure to add the widget to the Home screen.

1. Press HOME , and then tap  > Widget > People.
2. Choose the widget style, and then tap **Select**.
3. Select the group you want to add as a widget.
4. Drag the widget to a blank space on a Home screen, and then release.

## Setting the default communication method

1. Press HOME , and then go to the People widget.
2. Tap a contact on the widget.
3. On the Select default action screen, tap the communication method you want for the contact.

## Changing the default communication method

1. Tap the contact's name (not the photo) on the widget.
2. Press MENU and then tap **More > Set widget action**.
3. On the Select default action screen, tap the new communication method you want for the contact.

## Getting in touch with a contact

1. Press HOME , and then go to the People widget.
2. Tap a contact (photo not the name) on the widget. The default communication method will be performed.



Tap the name of the contact to open the contact details screen for that contact.

If you have not set a default communication method, the Select default action screen will open. See “Setting the default communication method” in this chapter for details.

# Keyboard

## Using the onscreen keyboard

---

When you start a program or select a field that requires text or numbers, the onscreen keyboard becomes available.

### Using the landscape onscreen keyboard

When entering text, you can choose to use the landscape orientation of the onscreen keyboard. Turn the phone sideways to use a larger keyboard that lets you type easily using two thumbs.



- The **Orientation** check box in **HOME**  > **MENU** > **Settings** > **Sound & display** needs to be selected for the screen orientation to automatically change.
- The landscape orientation keyboard is not supported in all applications.









### Changing the onscreen keyboard layout

You can choose from three different keyboard layouts to suit your typing style. To change the keyboard layout, do the following:

1. On the onscreen keyboard, press and hold .
2. Tap **Keyboard types**, and then select the keyboard layout that you want to use. Choose from the following:
  - **QWERTY**. This layout is similar to a desktop computer keyboard. This is the default keyboard layout.
  - **Phone Keypad**. This layout resembles the traditional mobile phone keypad.
  - **Compact QWERTY**. This layout features two letters on each key. The key size is slightly bigger than on the Full QWERTY layout.

## Entering text

Use the following keys while entering text using the onscreen keyboard:

	Press and hold keys with gray characters at the top to enter numbers, symbols, or accented letters. The gray character displayed on the key is the character that will be inserted when you press and hold that key. Some keys have multiple characters or accents associated with them.
	This is the Shift key. Tap to enter an uppercase letter. The next letter you type will be uppercase. Tap twice to turn on caps lock.
	Tap to switch to the numeric and symbol keyboard.
	This is the Enter key. Tap to create a new line.
	This is the Backspace key. Tap to delete the previous character.
	Tap to hide the onscreen keyboard.
	<ul style="list-style-type: none"> <li>Tap to activate voice input. When prompted, speak clearly into the microphone to enter your text onscreen.</li> <li>Press and hold to open the Touch Input settings menu to change the keyboard type, enable or disable predictive mode in the QWERTY keyboard, and adjust other input settings.</li> </ul>
	Tap to toggle between Multitap and XT9 predictive modes when using the Compact QWERTY or Phone keypad layout. For more information, see “Entering words with predictive text” below.

## Entering words with predictive text

The onscreen keyboard has predictive text to help you type quickly and accurately. Predictive text input is enabled by default, and word suggestions are displayed as you type.

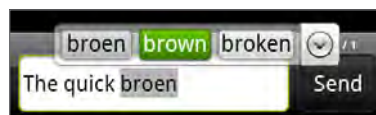

To enter a word in predictive mode, do any of the following:

- If you see the word you want highlighted in green or orange, you can simply tap the space bar to insert the word into your text.
- If you see the word you want shown in the suggestions before you have finished typing the entire word, tap the word to insert it into your text.
- If an arrow is shown to the right of the suggestion list, tap the arrow to see more suggestions.

## Adding a word to the predictive text dictionary

Your phone comes with a list of words that it references for predictive text suggestions. Sometimes you may need to add a word to the predictive text dictionary, for example a name or a specialized technical word.

While entering text using the QWERTY keyboard layout, if you tap any word on the suggestion list, it is automatically added to the predictive text dictionary if it was not in the dictionary already.

You can also add a word to the list manually:

1. On the onscreen keyboard, press and hold .
2. Tap User Dictionary.
3. Tap Add new.
4. Enter the word to add, and then tap OK.

## Editing or deleting a word in the user dictionary

You can edit or remove words that you previously added to the predictive text dictionary.

1. On the onscreen keyboard, press and hold .
2. Tap User Dictionary.
  - To edit a word, tap the word itself.
  - To delete a word, tap the X icon to the right of the word.

## Entering text with voice input

You can use the phone's microphone to input text vocally.

1. On the onscreen keyboard, press .
2. When prompted, say what you want written clearly into the microphone.



# Adjusting touch input settings

---

Open the Touch Input settings by doing one of the following:

- On any of the keyboard layouts, press and hold  to open the Touch Input settings.
- On the Home screen, press MENU and then tap **Settings > Language & keyboard > Touch Input**.

## Touch Input settings

### Keyboard types

Tap to select the keyboard layout to use. You can choose from QWERTY, Phone Keypad, or Compact QWERTY.

### Keyboard language

Tap to select the language layout of the keyboard.

### Text input

Tap to set text input options when entering text, calibrate the keyboard, and set a sound and/or vibration feedback whenever you tap a key. See “Text input” below for details.

### Tutorial

Learn how to use the onscreen keyboard with this interactive tutorial.

### User Dictionary

Add, edit or remove words in the predictive text dictionary. See “Entering words with predictive text” in this chapter for more information.

## Text input

### QWERTY

#### Prediction

Select to enable the word prediction feature which provides a list of possible words that reflect the characters of the keys you have tapped as well as characters of nearby keys.

#### Spell correction

Select to correct typographical errors by selecting from a list of possible words that reflect the characters of the keys you have tapped as well as characters of nearby keys.

### Phone keypad & compact QWERTY

#### Spell correction

Select to correct typographical errors by selecting from a list of possible words that reflect the characters of the keys you have tapped as well as characters of nearby keys.

#### Word completion

When using the Compact QWERTY or Phone keypad, lets you select from a list of possible combinations based on the characters that appear on the keys that you tapped.

## Other settings

### Sound feedback

Select to hear a clicking sound whenever you tap a key on the keyboard.

### Vibrate when typing

Select to enable vibration feedback whenever you tap a key on the keyboard.

## Finger touch precision

### Calibration tool

Tap to re-calibrate the keyboard touch accuracy. Re-calibrate the keyboard if you feel that the keyboard keys are not responding accurately to your taps.

### Reset calibration

Tap to reset the calibration back to factory default.

# Messages

## About Messages

---

**Messages** lets you compose and send text (SMS) and multimedia messages (MMS) to other mobile phones.

To open your message inbox, press HOME , and then tap  > **Messages**.

If the list of messages does not fit on the screen, you can scroll down to view more messages by swiping your finger on the screen or the optical joystick.

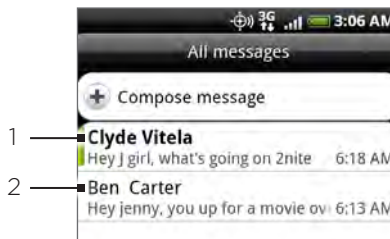

- 
- 1 Bold text indicates unread messages in the thread.
  - 2 Tap to open the message or message thread and read the text or view the picture message.
- 

## Sending text and multimedia messages



Send short text messages (SMS) and multimedia messages (MMS) to other mobile phones. If you exceed the limit on the number of characters for a single text message, your text message will be delivered as one but will be billed as more than one message. These are called concatenated messages.

Multimedia messages can contain text and a picture, a recorded voice, an audio or video file, a picture slideshow, contact card (vCard), or appointment (vCalendar).



The Messages application automatically converts a text message into a multimedia message when you enter an email address in the To field, add a message subject, attach an item, or compose a very long message.

### Sending a text message

1. Press HOME , and then tap  > **Messages**.
2. On the All messages screen, tap **New message**. The Compose screen opens.
3. Fill in one or more recipients. You can:
  - Enter phone numbers directly in the To field. If you're sending the message to several phone numbers, separate the phone numbers with a comma. As you enter information, any matching phone numbers from your contacts list are displayed. Tap a match to enter that number or address directly.
  - Tap the  icon, and then select the phone numbers of the contacts to whom you want to send the message. You can also select contact groups as recipients. When you have selected all the message recipients, tap **Done**.

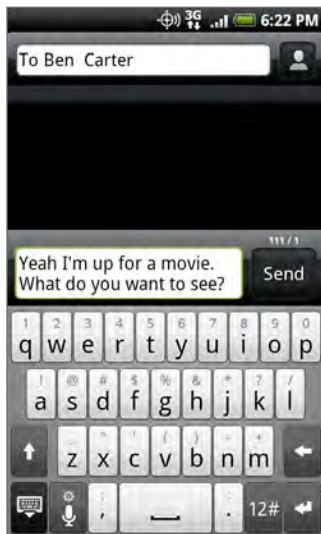

4. Tap the text box that contains the text “Tap to compose”, and then start composing your message.



5. When done, tap **Send** to send the text message.

 To receive delivery reports and know when a text message is received, in the All messages screen, press MENU and then tap **Settings**. In the SMS settings section, select the **Delivery reports** check box.

### Sending a multimedia (MMS) message

1. Press HOME , and then tap  > **Messages**.
2. On the All messages screen, tap **New message**. The Compose screen opens.
3. Fill in one or more recipients. You can:
  - Enter phone numbers or email addresses directly in the To field. If you're sending the message to several recipients, separate the phone numbers or email addresses with a comma.  
As you enter information, any matching phone numbers or addresses from your contacts list are displayed. Tap a match to enter that number or address directly.
  - Tap the  icon, and then select the contacts to whom you want to send the message. You can also select contact groups as recipients. When you have selected all the message recipients, tap **Done**.



You can add a subject line by pressing MENU and then tapping **Add subject**.

4. Tap the text box that contains the text “Tap to compose”, and then start composing your message.





Tap  to enter the message by speaking into the microphone.

5. Press MENU and then tap **Attach**.
6. On the Attach window, select from the following file attachments:
  - **Picture**. Select **Camera** to take a photo and attach it, or **Pictures** to attach a photo from your storage card.
  - **Video**. Select **Camcorder** to capture a video and attach it, or **Videos** to attach a video from your storage card.

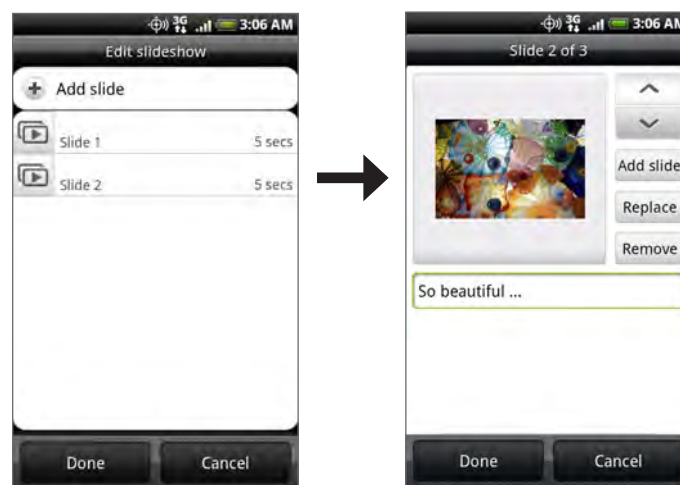
- **Audio.** Select **Voice Recorder** to make a voice recording and attach it, or **Music & sounds** to attach a music file or voice recording from your storage card.
- **Location.** You can attach location information. Send your current location (requires GPS to be turned on), a location stored in Footprints, or a location you pick on a map. For more information about GPS, maps, and Footprints, see the Maps and location chapter.
- **Contact (vCard).** Select a contact from your phone, and then select which contact information you want to attach.
- **Appointment (vCalendar).** Select the calendar event you want to attach.
- **Slideshow.** Opens the Edit slideshow screen. Tap **Add slide** to create a new slide. Tap the created slide (for example, Slide 1), tap **Insert picture**, and then select the picture you want to add to the slide. You can also navigate to the text box and enter a caption for the picture. When finished, tap **Done** to attach the slideshow to your message.



- When editing multiple slides, tap  to edit the next slide or tap  to return to the previous slide.
- While editing the slideshow, press MENU to let you preview the slideshow, add music or video to a slide, remove a slide, and more.

7. When you have finished composing the multimedia message, tap **Send**.

 To receive delivery reports and know when a picture message is received, in the All messages screen, press MENU, and then tap Settings. Select the **Delivery reports** check box in the MMS settings section.

### Saving and resuming a draft message

While composing a text or multimedia message, press **BACK**  to automatically save your message as a draft. To resume composing the message:



1. On the All messages screen, press MENU, and then tap **Drafts**.
2. Tap the message to resume editing it.
3. When you finish editing the message, tap **Send**.

## New message notifications

---

Depending on your notification settings, the phone will play a ringtone, vibrate, or display the message briefly in the status bar when you receive a new text or multimedia message. To change the notification for new text and multimedia messages, see “Setting text and multimedia message options” later in this chapter.



A new message icon  also appears in the notifications area of the status bar to notify you of a new text or multimedia message. The **Messages** application icon (if shown on the Home screen) also displays the number of new messages .

To open the message, press and hold the status bar, and then slide the status bar down to open the Notifications panel. Tap the new message to open and read it. For information on reading and replying to messages see “Managing message conversations” in this chapter.

## WAP push messages

---



WAP push messages contain a web link. Often, the link will be to download a file that you have requested, for example a ringtone.

When you receive a WAP push message, a notification icon  is displayed in the status bar.

### Opening the link contained in a WAP push message

1. Press and hold the status bar, and then slide the status bar down to open the Notifications panel.
2. Tap the new message.
3. Tap Visit website.

### Viewing all your WAP push messages

1. Press HOME , and then tap  > Messages.
2. Press MENU, and then tap Push messages.

## Managing message conversations

---

Text and multimedia messages that are sent to and received from a contact (or a number) are grouped into conversations or message threads in the All messages screen. Threaded text or multimedia messages let you see exchanged messages (similar to a chat program) with a contact on the screen.

### Reading a text message

Do one of the following:



- On the All messages screen, tap the text message or message thread to open and read it.
- If you have a new message notification, slide the status bar down to open the Notifications panel. Tap the new message to open and read it.

To return to the All messages screen from a text message thread, press MENU and then tap **All messages**.



- To view the details of a particular message, in the message thread, press and hold the message to open the options menu, and then tap **View message details**.
- If a message contains a link to a web page, tap the message and then tap the link to open it in the web browser.
- If a message contains a phone number, tap the message and then tap the phone number to dial the number or add it to your contacts.

### Viewing a multimedia message

1. Press HOME , and then tap  > **Messages**.
2. On the All messages screen, tap a multimedia message or message thread to open it.
3. Tap the attachment to open it.
 



If the attachment is a vCard contact, it is imported to your Phone contacts list. For information about contacts, see the People chapter.

If the attachment is a vCalendar file, you can choose the calendar where you want to save the event. For information on using Calendar, see the Calendar chapter.
4. To save the attachment to the storage card, press and hold the sender's name or number, and then tap **Save [attachment type]** on the options menu.



- When **Auto-retrieve** in MMS settings is disabled, only the message header is downloaded. To download the entire message, tap the **Download** button at the right side of the message. For details, see "Setting text and multimedia message options" later in this chapter.
- If you are concerned about the size of your data downloads, check the multimedia message size before you download it.

### Replying to a text or multimedia message

1. Press HOME , and then tap  > **Messages**.
2. On the All messages screen, tap a text or multimedia message thread to open it.
3. Tap the text box at the bottom of the screen, enter your reply message, and then tap **Send**.





To reply to a text message with a multimedia message, open the text message, press MENU and then tap **More** > **Add subject**, or **Attach**. The text message is automatically converted into a multimedia message.





## Protecting a message from deletion

You can lock a message so that it will not be deleted even if you delete the other messages in the conversation.

1. Press HOME , and then tap  > Messages.
2. On the All messages screen, tap a message thread.
3. Press and hold the message that you want to lock
4. Tap **Lock message** on the options menu.

A lock icon  is displayed at the right hand side of the message.



## Deleting a message thread

1. Press HOME , and then tap  > Messages.
2. On the All messages screen, tap the message thread that you want to delete.
3. Press MENU, and then tap **Delete**.
4. When prompted to confirm, tap **OK**.



Any locked messages in the thread will not be deleted unless you select the **Delete locked messages** check box.

## Deleting several message threads

1. Press HOME , and then tap  > Messages.
2. On the All messages screen, press MENU, and then tap **Delete**.
3. Select the message threads you want to delete.
4. Tap **Delete**. Any locked messages will not be deleted.

## Deleting a single message



1. While viewing a message thread, press and hold the message that you want to delete.
2. If the message is locked, tap **Unlock message** on the options menu, and then press and hold the message to display the options menu again.
3. Tap **Delete message** on the options menu.
4. When prompted to confirm, tap **OK**.

## Viewing contact details and communicating with a contact

When you have received a message from someone in your stored contacts, you can tap the contact's photo or icon in the message thread to open a menu of options. Depending on the stored contact information, you can view the contact details, phone or send an email message to the contact, and more.

## Setting text and multimedia message options

---

Press HOME , and then tap  > Messages. On the All messages screen, press MENU and then tap **Settings** to set the text or multimedia message options. You can set the following:

### SMS settings

#### Delivery reports

Select this option to receive a report on the delivery status of your message.

#### Priority setting

Set the message priority of SMS messages sent

#### Send callback number

Enable your phone to include a number with the text message to allow the recipient to call you back by pressing the SEND button.

#### Callback number

Set the callback number.

### MMS settings

#### Delivery reports

Select this option to receive a report on the delivery status of your message.

#### Auto-retrieve

Select this option to automatically retrieve all your MMS messages completely. When selected, the MMS message header plus the message body and attachments will automatically download to your phone. If you clear this check box, only the MMS message header will be retrieved and shown in your All messages screen.

#### Priority setting

Set the message priority of MMS messages sent.

#### Maximum message size

Set the maximum file size of an MMS message. The MMS message will not be sent out if it exceeds the file size set here.

### Received messages

#### Received notification

Select this option if you want to receive a notification in the status bar when a new text or multimedia message arrives.

#### Play notification sound

If you want the phone to ring when a new message arrives, select this option.

#### Notification sound

Select a ringtone that is specific to new text and multimedia messages. Note that the ringtone briefly plays when selected.

#### Vibrate

Select this option if you want the phone to vibrate when a new text or multimedia message

arrives.

## Sent messages

### Sent notification

Select this option if you want to receive a notification in the status bar when a message is sent successfully.

### Failure notification

Select this option if you want to receive a notification in the status bar when a message is not sent successfully.

### Play notification sound

If you want the phone to ring when a sent or failure notification is received, select this option.

### Notification sound

Select a ringtone that is specific to sent or failure notifications. Note that the ringtone briefly plays when selected.

### Vibrate

Select this option if you want the phone to vibrate when a new text or multimedia message arrives.

## Adding the Messages widget

---

Add the Messages widget to let you read your messages on the Home screen. To learn how to add widgets, refer to “Adding a widget to your Home screen” in the Personalizing chapter.

# Accounts and sync

## Synchronizing with online accounts

---

Your phone can sync information and receive updates from your Google™ and Microsoft® Exchange ActiveSync® accounts as well as popular online services such as Facebook®, Twitter™, and Flickr™.

These are some of the types of information you can sync:

- Gmail™/Google Mail and Exchange ActiveSync email.
- Google and Exchange ActiveSync contacts, as well as your Facebook friends' contact information. For information on contacts, see the People chapter.
- Calendar events from your primary Google Account and from Exchange ActiveSync. For information on using Calendar, see the Calendar chapter.
- Status updates and links shared by your friends and yourself on social networks such as Facebook and Twitter. For details, see the Social chapter.
- Flickr and Facebook photo uploads. For information on viewing photos, see the Photos chapter.

### Adding a social network account

You can sync with your accounts on popular online services such as Facebook, Twitter, and Flickr.

1. Press HOME  > MENU, and then tap **Settings > Accounts & sync**.
2. Tap **Add account**, and then tap the account type you want to add.
3. Follow the onscreen instructions to enter the account information.

When you have finished, the account is added to the list on the Accounts & sync screen. Depending on how you configured the account, the new information may start synchronizing with your phone.

### Synchronizing with a Google Account

Signing in to your Google Account lets you synchronize Gmail/Google Mail and your Google contacts and calendars between your phone and the web. You also need to sign in to a Google Account to use Google applications such as Google Talk™ and Android Market.

You can add more than one Google Account on your phone. However, subsequent Google Accounts can only synchronize Gmail/Google Mail and contacts. Other Google services use the first Google Account you added.

1. Press HOME  > MENU, and then tap **Settings > Accounts & sync**.
2. Tap **Add account > Google**.
3. Follow the onscreen instructions to sign in to an account or create a new account.

## Synchronizing with a Microsoft Exchange ActiveSync account

You can only add one Microsoft Exchange ActiveSync account on your phone. You can sync with Microsoft Exchange Server 2003 Service Pack 2 (SP2) or later.

1. Press HOME  > MENU, and then tap **Settings > Accounts & sync**.
2. Tap **Add account > Exchange ActiveSync**.
3. Enter the Exchange ActiveSync account details, and then tap **Next**.



Your corporate Exchange Server must support auto-detect for the phone to automatically set up the Exchange ActiveSync account. If your corporate Exchange Server does not support auto-detect, you will need to enter your Exchange Server settings after you tap **Next**. Ask your Exchange Server administrator for details.

4. Select the types of information you want to synchronize, and then tap **Finish setup**.

## Managing your accounts

### Changing general sync settings

1. Press HOME  > MENU, and then tap **Settings > Accounts & sync**.
2. Select or clear the following:
  - **Background data.** If this is selected, applications can send and receive online account information even if you are not currently using them.
  - **Auto-sync.** If this is selected, applications can use the sync schedule defined in the account settings. If this is cleared, you will need to sync accounts manually. For instructions on doing this, see “Synchronizing an account manually” below.

### Changing account settings

You can change settings such as the sync frequency and the types of information synchronized, the kinds of notification you receive, and the way that account information is displayed.

1. Press HOME  > MENU, and then tap **Settings > Accounts & sync**.
2. Tap the account that you want to edit.
3. Edit the account settings.

### Synchronizing an account manually

1. Press HOME  > MENU, and then tap **Settings > Accounts & sync**.
2. Tap the account that you want to sync.
3. Tap **Sync now**.

### Removing an account

You can remove an account to delete it and all information associated with it from your phone, for example messages, contacts, or settings. Removing an account does not delete information from the online service itself.



You cannot remove some accounts, such the first Google Account you signed into on the phone, except by deleting all personal information from your phone with a hard reset. For instructions on doing this, see “Performing a hard/factory reset” in the Backup, update and reset chapter.

1. Press HOME  > MENU, and then tap **Settings > Accounts & sync**.
2. Tap the account that you want to remove.
3. Tap **Remove account**, and then confirm that you want to remove the account.

## Using HTC Sync

---

Are you using Microsoft Outlook or Outlook Express on your computer? You can use **HTC Sync** to synchronize your Outlook contacts and calendar or your Outlook Express contacts with your phone. Before you do a factory reset or a software (ROM) upgrade of your phone, you can also use HTC Sync to back up and sync this information from your phone back to your computer.

Here's what you'll need to do to install, set up, and use HTC Sync on your computer:

1. Download and install HTC Sync from the HTC support website. See "Downloading the latest HTC Sync upgrade" for details.
2. Connect your phone to your computer using the supplied USB cable and set up HTC Sync to recognize your phone. Follow the steps in "Setting Up HTC Sync to recognize your phone".
3. Choose what information to sync between your computer and your phone and how you want to sync them.
  - To easily set up synchronization using HTC Sync's guided wizard, follow the steps in "Setting up synchronization".
  - To choose from more sync options, see "Setting up more sync options".
4. Sync your computer with your phone automatically or manually. See "Synchronizing your phone" for details.

Here's more you can do with HTC Sync:

- If you have third-party applications on your computer (not from Android Market), you can use HTC Sync to install them from your computer to your phone. For more information, see "Installing apps from your computer to your phone".
- Repair contacts and/or calendar data, only if needed.

### Installing HTC Sync



- HTC Sync requires USB 2.0 on your computer to connect and sync with your phone. To see a complete list of the computer and software requirements, you can check them in the HTC Sync software download page on the HTC support website:  
[http://www.htc.com/www/SupportViewNews.aspx?dl\\_id=847&news\\_id=471](http://www.htc.com/www/SupportViewNews.aspx?dl_id=847&news_id=471)
  - For trouble-free installation, first quit all running programs and temporarily exit from your anti-virus program before you start installing HTC Sync.
1. Download HTC Sync from the HTC support website. See "Downloading the latest HTC Sync upgrade" for details.
  2. Run "HTC Sync.exe" to install it to your PC.
  3. From your PC, launch HTC Sync, and use the USB cable to connect your phone to the PC (if the phone is not connected to the PC there will be a sync failure).
  4. On your phone, check Notifications on the status bar for the icon to confirm if HTC Sync recognizes the phone.
  5. The first time you synchronize the phone, the Synchronization Settings Wizard will start automatically to help you set up HTC Sync. (If the Synchronization Settings Wizard does not start, click **Synchronize Now** on the HTC Sync screen.)
  6. On your PC, follow the instructions to finish the wizard on the HTC Sync screen.

## Setting up HTC Sync to recognize your phone

After installing, set up HTC Sync to recognize your phone.

1. Connect your phone to the computer with the supplied USB cable. Or, if your phone is already connected, press and hold the status bar and drag your finger down to open the Notifications panel. Then tap the status that shows “Select to change USB connection type”.
2. On the Connect to PC screen in your phone., tap **HTC Sync** and then tap **Done**.
3. Your phone attempts to find HTC Sync on your computer. Wait for a few seconds for the process to finish.



If your phone displays a message indicating that it's unable to find HTC Sync, try disconnecting and reconnecting the USB cable, and then repeat step 2.

4. When your phone finds HTC Sync, your computer will display the Phone Connection Wizard. Click **Next**.
5. Enter the name you want for your phone, and then click **Finish**.
6. Check the HTC Sync icon at the bottom-right side of your computer screen. If it appears green in color, that means your phone has successfully connected with your computer and HTC Sync recognizes your phone.



## Setting up synchronization

You can set up HTC Sync to synchronize your computer's Outlook contacts and calendar events with your phone. If you're using Outlook Express on your computer, you can only sync contacts with your phone.



Before you begin setting up synchronization, make sure you have set up HTC Sync to recognize your phone. If you have not yet done so, follow the steps in “Setting up HTC Sync to recognize your phone”.

1. On your computer, check and make sure the HTC Sync icon  at the bottom-right side of the screen appears in green which means that your phone is connected to HTC Sync.
2. Double-click the green HTC Sync icon on your computer to open HTC Sync.
3. Click **Synchronize Now**. (You can also click **Sync Manager > Settings**.)
4. In the Synchronization Settings Wizard, click **Next**.
5. In the next few dialog boxes, choose whether to sync Outlook or Outlook Express, select the type of information to sync (contacts and/or calendar), and choose to sync them automatically or manually with your phone.
6. Click **Finish**.  
HTC Sync then starts to sync your phone and your computer. Wait for the synchronization to finish.
7. A summary report is then displayed. Click **Close**.

## Setting up more sync options

HTC Sync gives you the flexibility to set many options, such as setting a sync schedule, choosing how to resolve conflicts when the same items are found on both the phone and the computer, and more.

1. On your computer, check and make sure the HTC Sync icon  at the bottom-right side of the screen appears in green which means that your phone is connected to HTC Sync.
2. If HTC Sync is not open, double-click the green HTC Sync icon to open it.
3. Click **Sync Manager > Settings**.
4. In the Synchronization Settings Wizard dialog box, click **Manual settings**.
5. From the left side of the Sync Manager Settings dialog box, click the type of setting you want to change, and then choose from the available options on the right. Settings that can be changed include the following:

### Contacts or Calendar folder to sync with

Change this only if you have personal folders created in your Outlook and you need to sync with a personal folder. Click **Contacts** or **Calendar** on the left side of the dialog box, click the **Properties** button, and then choose the personal folder to sync with.

### Calendar events to sync with

Choose the number of days of calendar events to sync. Click **Calendar** on the left side of the dialog box, click **Properties**, and then set the days under **Date range**.

### Conflict policy

In cases when the same contacts and/or calendar items exist in both your phone and your computer, choose whose data you want to keep when a conflict occurs.

### When to sync

Click **Automatic sync** on the left side of the dialog box. Then choose whether to sync manually, auto sync everytime you connect your phone to your computer, or sync at a set schedule.

6. Click **Apply** to save the sync options you've selected, and then click **OK**.

## Synchronizing your phone

After you've installed and set up HTC Sync, you can sync your phone with your computer.

### Synchronizing your phone with your computer automatically

Do the following first to make sure your phone will sync automatically with your computer:

1. Press HOME  > MENU, and then tap **Settings > Applications > Development**.
2. Make sure the **USB debugging** check box is selected.

Whenever you connect your phone to your computer, synchronization starts automatically. Wait for the sync process to finish.



## Synchronizing your phone with your computer manually

1. Connect your phone to the computer with the supplied USB cable. Or, if your phone is already connected, press and hold the status bar and drag your finger down to open the Notifications panel. Then tap the status that shows “Select to change USB connection type”.
2. On the Connect to PC screen in your phone., tap **HTC Sync** and then tap **Done**.
3. On your computer, check and make sure that the HTC Sync icon  at the bottom-right side of the screen appears in green which means that your phone is connected to HTC Sync.
4. On your phone, tap **Sync now**.

## Downloading the latest HTC Sync upgrade

Visit the HTC support website ([www.htc.com/support](http://www.htc.com/support)) from time to time to check for the most recent HTC Sync upgrade so you can download and install it on your computer.

After installing the latest upgrade, set up HTC Sync again to recognize and sync with your phone. Follow the steps in “Setting up HTC Sync to recognize your phone” and “Setting up synchronization”.

## Installing apps from your computer to your phone

If you have applications (.apk files) on your computer, you can use HTC Sync to install them to your phone. We strongly recommend you install only applications that you trust.

1. On your phone, press HOME  > MENU, tap **Settings** > **Applications**, and then select the **Unknown sources** check box to allow applications from your computer to be installed to your phone.



You only have to do this step once. You do not need to do this step again next time you install another application from your computer to your phone.

2. Connect your phone to the computer with the supplied USB cable. Or, if your phone is already connected, press and hold the status bar and drag your finger down to open the Notifications panel. Then tap the status that shows “Select to change USB connection type”.
3. On the Connect to PC screen in your phone., tap **HTC Sync** and then tap **Done**.
4. On your computer, double-click the green HTC Sync icon  to open HTC Sync.
5. In HTC Sync, click **Application Installer**.
6. In the Application Installer file types dialog box, make sure that the **Android OS installer file (apk)** check box is selected and then click **OK**.



This dialog box only appears the first time you use the Application Installer.

7. Click **Next**.
8. Click **Browse**, locate the application (.apk) on your computer, and then click **Open**.
9. After selecting the application, click **Next**.
10. Click **Finish**. Check your phone’s screen to see if there are additional instructions to complete the installation.

# Social

## Facebook for HTC Sense and Facebook for Android application

---

### Facebook for HTC Sense

View your Facebook® updates in supported applications on the phone. By signing in to Facebook for HTC Sense, your Facebook contacts and their contact details are downloaded to People, you can browse through Facebook photo albums in Photos, and read Facebook status updates in Friend Stream. To learn how to sign in to Facebook for HTC Sense, see the Accounts and sync chapter.

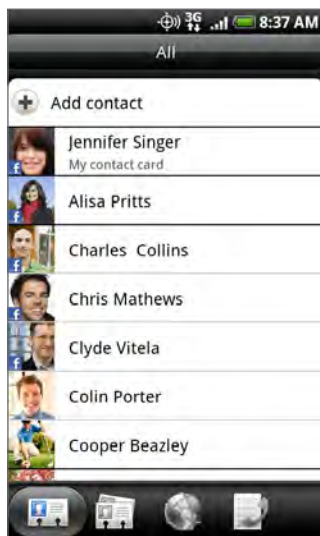

People

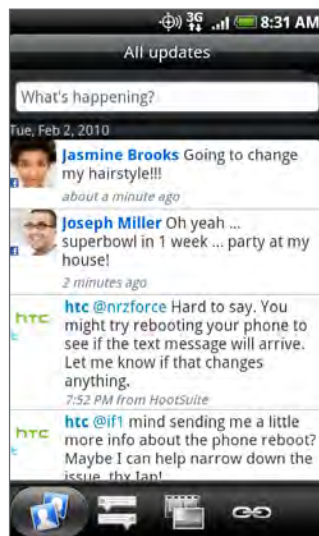

Friend Stream

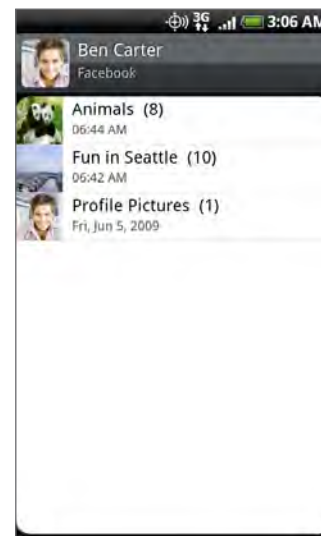

Photos



### Facebook for Android application

The Facebook application on your phone lets you keep up and stay close with your friends in Facebook. It offers most of the features that you are familiar with when using Facebook on your computer.



If you have more than one Facebook account, you can sign in to the Facebook application using your other Facebook account.

### Using the Facebook application

1. Press HOME , and then tap  > Facebook.
2. If this is your first time to use Facebook, follow the onscreen instructions to sign in to your Facebook account.
3. On the News Feed screen, press MENU, and then tap Home to access the other functions.



- While on the Facebook home screen, press MENU, and then tap Settings to set refresh and notification options.
- On some Facebook screens, you can press and hold an item to open an options menu.

### With the Facebook application, you can:



- Share your thoughts and check other people's status updates.
- View your friends list and write on someone's wall.
- Comment on a friend's post.
- View someone's personal information, including photo albums.
- Check your Facebook notifications.
- Take a photo and upload it straight to your Facebook account.

### Adding the Facebook widget

Add the Facebook widget to the Home screen to let you quickly share your thoughts and view your friends' status updates.



The widget will only link to the Facebook account that you logged into on the Facebook application.



1. Press HOME , and then tap  > Widget > Facebook.
2. Choose the widget style, and then tap **Select**.
3. Drag the widget to a blank space on the Home screen, and then release.

### Differences between Facebook for HTC Sense and Facebook for Android application

- Facebook for HTC Sense is not a standalone application. It is integrated into People, Friend Stream, and Photos to give you up-to-date information about your Facebook contacts (their status updates and new photos) in these applications.
- The Facebook for Android application is a standalone application. Use this application to do most of the things that you would do when you're using your computer's web browser to access your Facebook account, such as adding a friend and adding captions to photos you upload.
- The two do not share the same login credentials. Signing in to Facebook for HTC Sense does not sign you in to the Facebook application and vice versa. If you want to use the same Facebook account for both, you'll have to sign in to both using the same login credentials.

## Twittering on your phone

Peep is a Twitter™ client that lets you enjoy “twittering” on your phone. Send out tweets, read and receive tweets from people, search for new Twitter users to follow, all from your phone.



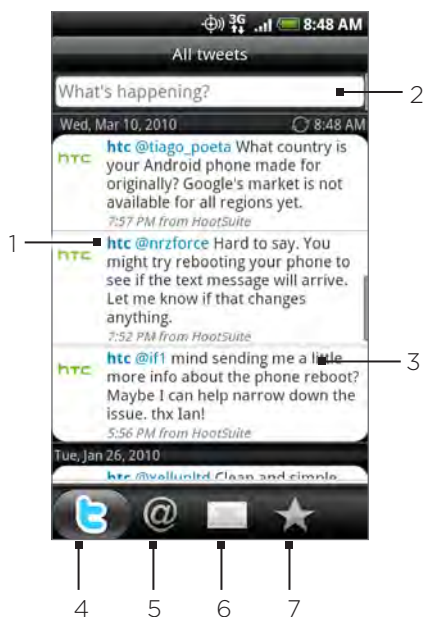

1. Press HOME , and then tap  > Peep.
2. If you did not sign in to your Twitter account when you first turned on the phone, follow the onscreen instructions to sign in to your Twitter account.
3. Peep opens in the All Tweets tab. Slide your finger on the bottom row to go to the tab you want.

### Peep screen







- 
- 1 Tap to view the Twitter user’s profile. This also shows you all tweets from this Twitter user.
  - 2 Tap to enter a tweet to send out.
  - 3 Press and hold to open the options menu to let you reply, send a direct message, retweet, add to favorite, and view the profile.
- 
- 4 Shows all the tweets from people you follow and tweets that you have sent out.
  - 5 Shows all tweets that mentions your username using the “@[your username]” convention.
  - 6 Shows all private/direct messages that you have received or sent out.
  - 7 Shows tweets that were marked as favorites.
- 

### Sending a tweet

1. Press HOME , and then tap  > Peep.
2. On the All Tweets tab, tap the text field with the words “What’s happening?”.
3. Enter your tweet, and then tap **Update**. Before tapping **Update**, you can:
  - Tap  to post a picture from Photos or Camera to your default photo hosting site and add the link to the picture into the tweet.
  - Tap  to insert your location into the tweet. You can choose to add a map link, insert your location name, or insert your position coordinates.

## Searching for Twitter users to follow



1. Press HOME , and then tap  > Peep.
2. While on the Peep screen, press the SEARCH  button.
3. Tap the text field with the words "Search Twitter", enter the search criteria, and then tap .
4. On the Search result screen, scroll through the list, and then tap the twitter user you want to follow.



The search results will also list down tweets that contain the search word.



5. Press MENU, and then tap Follow.

## Unfollowing a Twitter user

1. Press HOME , and then tap  > Peep.
2. On the All Tweets tab, tap Twitter user you want to stop following.
3. Press MENU, and then tap Unfollow.

## Sending a direct message

You can only send a direct message to someone who is following you.

1. Press HOME , and then tap  > Peep.
2. Press MENU, and then tap New message.



You can also send a direct message from the All Tweets or Direct Message tab. On the All Tweets or Direct Message tab, press and hold the person you want to send the direct message to, and then tap Send direct message on the options menu.

3. Tap the To field, and then enter the name. As you enter characters, the names of the Twitter users that match the characters you enter will appear. Tap the name when you see it.
4. Enter your message, and then tap Update.

## Setting Peep options

1. Press HOME , and then tap  > Peep.
2. Press MENU, and then tap More > Settings. You can set these options:

### Account settings

Sign out of your Twitter account.

### General settings

Choose whether to show the screen name or the real name of the people you follow.

### Send & receive

Set the frequency to check for new tweets and set the number of tweets to download.

### Services



Set your photo hosting site, photo quality, location options, and URL shortening host.

### Notification settings

Select when to be notified and how you want to be notified.



## Adding the Twitter widget

Add the Twitter widget to let you send and follow your tweets right on the Home screen.

1. Press HOME , and then tap  > Widget > Twitter.
2. Choose the widget style, and then tap **Select**.
3. Drag the widget to a blank space on the Home screen, and then release.

## Using Friend Stream

Streamline your social network accounts through Friend Stream. Update your status simultaneously, view status updates, and look through photo updates from your Facebook, Twitter, and other social network accounts using Friend Stream.

1. Press HOME , and then tap  > Friend Stream.
2. If you are not signed in to a social network account, press MENU, tap Settings > Accounts & sync, and then tap the account you want to sign in to.
3. Friend Stream opens in the All Updates tab. Slide your finger on the bottom row to go to the tab you want.

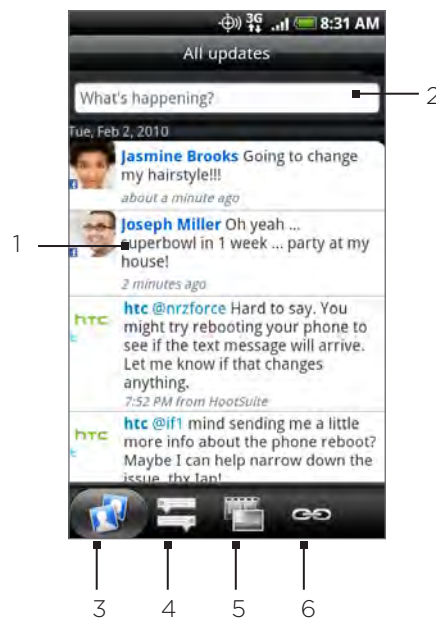

### Friend Stream screen

Only updates from accounts that you are signed in to will be shown. You can filter the updates that show in Friend Stream by pressing MENU, and then tapping Settings > Show updates.



- 
- 1 Depending on the type, tap to open Peep, post a Facebook comment, look at the Flickr album, or open the link in the web browser.
  - 2 Tap to enter and send a status update.
  - 3 Shows all the messages from the social network accounts that you are signed in to.
  - 4 Shows only status updates from Facebook and Twitter.
  - 5 Shows only photo updates from Facebook and Flickr.
  - 6 Shows only links posted on Facebook.
-

## Updating your status

1. Press HOME , and then tap  > **Friend Stream**.
2. On the **All Updates** tab, tap the text field with the words “What’s on your mind?”.
3. Tap , and then on the Update Status dialog box, select which accounts you want the status update to be posted. Tap **Done**.





Only the accounts that you are signed in to will be shown on the dialog box.

4. Enter your status update, and then tap **Share**.

## Adding the Friend Stream widget

Add the Friend Stream widget so you can update your status simultaneously and view status updates from your social network accounts right on the Home screen.

1. Press HOME , and then tap  > **Widget** > **Friend Stream**.
2. Choose the widget style, and then tap **Select**.
3. Drag the widget to a blank space on the Home screen, and then release.



# Chatting in Google Talk

---

Google Talk is Google's instant messaging program. It lets you communicate with other people that also use Google Talk.

## Signing in to Google Talk

If you signed in to your Google Account when you first set up the phone, you are already signed in to Google Talk.

1. Press HOME , and then tap  > Talk > Next > Sign in.
2. Enter your Google Account username and password, and then tap **Sign in**.

When you are signed in to Google Talk, your online status in Google Talk will also appear in other Google Apps such as Gmail/Google Mail and Google Maps.



## Signing out of Google Talk

If you are not going to use Google Talk for an extended period of time, we recommend that you sign out of Google Talk to save battery power.

1. Press HOME , and then tap  > Talk.
2. In the Friends list, press MENU, and then tap **More > Sign out**.

## Chatting with friends

### Starting a chat

1. Press HOME , and then tap  > Talk.
2. Tap a friend in the Friends list.
3. Chat with your friend by entering text in the text box at the bottom of the screen.



To insert a smiley, press MENU, and then tap **More > Insert smiley**. Tap a smiley to insert it into your message.

4. After entering your message, tap **Send**.

### Accepting an invitation to chat

When a friend sends you a Google Talk message, you receive a notification. Their entry in the Friends list turns white and displays the message.

Do one of the following:

- In the Friends list, tap the friend who sent you the invitation to chat.
- Open the Notifications panel, and then tap the chat notification. See "Opening the Notifications panel" in the Basic chapter to learn how to open the Notifications panel.

### Returning to the Friends list

While on a chat screen, press MENU, and then tap **Friends list**.

## Switching between active chats

You can switch between chats if you have more than one chat going.

1. While on a chat screen, press MENU, and then tap **Switch chats**.
2. On the screen that opens, tap the friend you want to chat with.

## Inviting a friend to join a group chat

1. While on a chat screen, press MENU, and then tap **Add to chat**.
2. Tap the friend you want to invite. The friend you invited and the current participants receive an invitation to a group chat. Each one who accepts the invitation joins the group chat.

## Chatting on or off the record

Your Google Talk messages are stored, so you can review them later and even search for them in the Chats folder in Gmail/Google Mail. But, if you'd rather not store the messages in a chat, you can go off the record.

1. On a chat screen, press MENU, and then tap **Chat off record**.
2. To resume saving the messages in the chat, press MENU, and then tap **Chat on record**.



## Ending a chat

Do one of the following:

- In the Friends list, press and hold the friend you want to stop chatting with, and then in the menu that opens, tap **End chat**.
- While on a chat screen, press MENU, and then tap **End chat**.

## Changing your online status and picture



### Changing your online status

1. Press HOME , and then tap  > Talk.
2. In the Friends list, tap the online status icon (  ) beside your name, and then select the status you want on the options menu.



In addition to the standard status settings described in the table, you can also select a message that you've entered previously. Or tap **Clear custom messages** to erase them and start over.

Your status and any message appear in your contact's Friends lists and in other locations where your status or status message are displayed.

### Changing your status message

1. Press HOME , and then tap  > Talk.
2. In the Friends list, tap the text box to the left of your online status icon, and then enter your status message.
3. On the onscreen keyboard, tap .



## Changing your picture

1. Press HOME , and then tap  > Talk.
2. In the Friends list, tap the picture to the left of your status message.
3. In the Select an album screen, tap the album where the picture you want to use is located.
4. Tap the picture you want to use.
5. Drag the green box to select the portion of the picture to crop, and then tap **Save**.

## Managing your Friends list



### Adding a friend

You can invite anyone with a Google Account to become your friend in Google Talk, so you can chat with each other and view each others' online status.



1. Press HOME , and then tap  > Talk.
2. In the Friends list, press MENU and then tap **Add friend**.
3. Enter the Google Talk instant messaging ID or Google email address of the friend you want to add.

### Accepting an invitation to become a friend

When a contact invites you to become a friend in Google Talk, you receive a notification in the Status bar and the invitation appears in your Friends list.



1. Press HOME , and then tap  > Talk.
2. In the Friends list, tap **Chat invitation**.
3. Do one of the following:
  - Tap **Accept** in the menu that opens to accept the invitation.
  - Tap **Cancel** if you don't want to chat with and share your Google Talk status with the sender.

### Viewing the list of pending invitations to friends



1. Press HOME , and then tap  > Talk.
2. In the Friends list, press MENU, and then tap **Invites**. All the friends to whom you've extended invitations to become friends on Google Talk appear in the list until they accept or cancel your invitation.
3. Tap a pending invitation, and then tap **Accept** or **Decline**.

### Viewing all friends or only those most popular with you

By default, only the friends that you frequently chat with — the most popular — are shown in the Friends list. But you can view all friends instead.

1. Press HOME , and then tap  > Talk.
2. In the Friends list, press MENU, and then tap **All friends**. To switch back to just the friends with whom you chat most frequently, tap **Most popular** in the menu.

## Making a friend popular

1. Press HOME , and then tap  > Talk.
2. In the Friends list, press and hold a friend's name.





If you cannot see the friend, press MENU, and then tap **All friends**.

3. In the options menu, tap **Always show friend**.

## Blocking a friend

You can block a friend from sending you messages. When blocked, your friend is also removed from your Friends list.

1. Press HOME , and then tap  > Talk.
2. In the Friends list, press and hold the friend's name you want to block.



If you cannot see the friend, press MENU, and then tap **All friends**.

3. In the options menu, tap **Block friend**. Your friend is removed from your friends list and is added to the blocked friends list.





To unblock a friend, in the Friends list, press MENU and then tap **Blocked**. In the Blocked friends list, tap the name of the friend you want to unblock, and then tap **OK** when prompted.

## Changing Google Talk settings



### Setting notifications for new Google Talk messages

You can set the phone to play a sound, vibrate, or display a notification icon in the status bar each time you receive a new instant message.

1. Press HOME , and then tap  > Talk.
2. In the Friends list, press MENU and then tap **More > Settings**.
3. Select the **IM notifications** check box to receive a notification (  ) in the status bar when a new instant message arrives.
4. Do one of the following:
  - Tap **Select ringtone** to select the ringtone to use when a new instant message arrives. The ringtone briefly plays when selected. If you don't want a ringtone to play when you receive a new Google Talk message, select **Silent**.
  - Select the **Vibrate** check box to vibrate your phone when you receive a new Google Talk message.

## Showing or hiding the mobile indicator to friends

You can check what type of device your friend is using to chat in Google Talk. In the friends list, check the image that appears to the right of your friend's name.

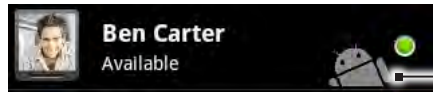

1. Press HOME , and then tap  > Talk.
2. In the Friends list, press MENU, and then tap **More > Settings**.
3. Select the **Mobile indicator** option.



Indicates that the friend is using an Android phone.

## Setting whether you sign into Google Talk automatically

You can sign in to your Google Talk account automatically every time you turn on your phone.

1. Press HOME , and then tap  > Talk.
2. In the Friends list, press MENU, and tap **More > Settings**.
3. Select the **Automatically sign in** check box.

# Email



## Using Gmail/Google Mail

Gmail/Google Mail is Google's web-based email service. Gmail/Google Mail is configured when you first set up your phone. Depending on your synchronization settings, Gmail/Google Mail on your phone is automatically synchronized with one or more Gmail/Google Mail accounts on the web. For more information about synchronization, see "Synchronizing with a Google Account" in the Accounts and sync chapter.

### Viewing your Gmail/Google Mail inbox

The Inbox conversations list is your default Gmail/Google Mail view. All your received email messages are delivered to your Inbox.

Gmail/Google Mail groups each message you send with all the responses you receive. This conversation list continues to grow as new replies arrive, so you can always see your messages in context. A new message or a change to the subject of a current message will begin a new conversation.

1. Press HOME , and then tap  > Gmail/Google Mail.
2. To scroll through the conversation list, swipe your finger up/down on the screen or the optical joystick.

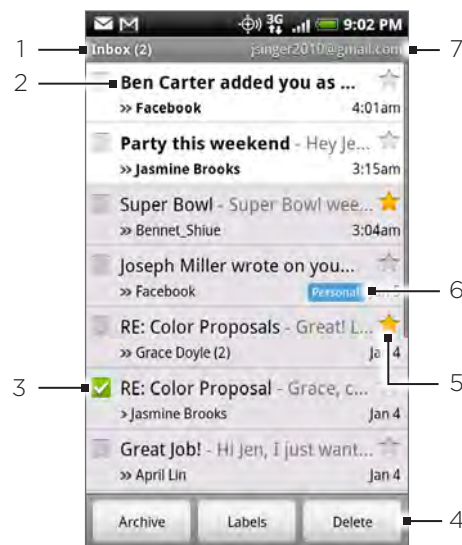

- 
- 1 Folder (or Label) and number of unread email messages.
  - 2 Unread messages are displayed in bold.
  - 3 Checked email. Select one or more emails to apply an action.  
Note: Batch operations needs to be enabled.
  - 4 Actions for checked email(s). This will not show if there is no item selected in the inbox.
  - 5 Starred message. Tap to add or remove the star. For more information, see "Starring a message" in this chapter.
  - 6 Message label.
  - 7 The Google Account you are currently viewing. To view another account, see "Switching to another Google Account" below.
-

## Switching to another Google Account

If you have set up more than one Google Account on your phone, you can switch between accounts in Gmail/Google Mail. For more information on setting up Google Accounts, see “Synchronizing with a Google Account” in the Accounts and sync chapter.

1. While viewing the Inbox, deselect any checked email messages.
2. Press MENU, and then tap **Accounts**.
3. Tap the account to switch to.

## Reading your messages

Depending on your notification settings, the phone plays a ringtone, vibrates, or displays the email message briefly in the status bar when you receive a new email. A new email message icon  also appears on the notifications area of the status bar to notify you of a new email. For more information on email notification settings, refer to “Changing Gmail/Google Mail settings” later in this chapter.

For information on automatic email synchronization, see “Changing Gmail/Google Mail synchronization settings” in this chapter.



To refresh your inbox manually, press MENU and then tap **Refresh**.

1. Do one of the following:
  - When you receive a new email notification, press and hold the status bar, and then slide your finger down on the screen to open the Notifications panel. Tap the new email to view it.
  - While in the Inbox, tap the unread email or the conversation with the unread email to view it.
2. To scroll through the messages in the conversation, swipe your finger up/down on the screen or the optical joystick.

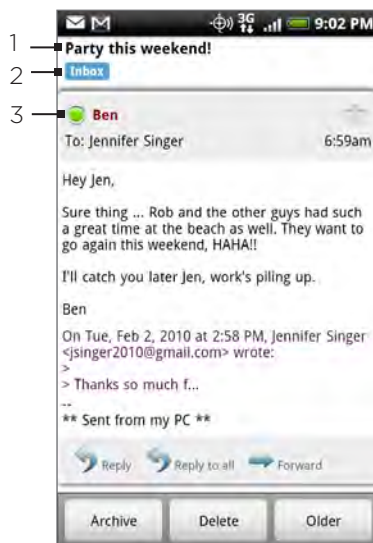

- 
- 1 Message subject.
  - 2 Message label.
  - 3 Online status. Appears when the contact is a Google Talk friend and you are signed in to Google Talk.
-

3. To manage the email message or conversation, do any of the following:

- Tap **Archive** to remove the conversation from your Inbox while still keeping it stored in your Google Account.



To display your archived messages, in the Inbox, press MENU and then tap **View labels > All Mail**.

- Tap **Delete** to delete the conversation from your Google Account. If you delete the conversation accidentally, you can tap **Undo** in the yellow bar at the top of the screen to undelete it.
- Tap **Older** to see the previous conversation in your Inbox.
- Press MENU to see more options.

### Replying to or forwarding an email message

1. In the message thread, scroll down to the end of the conversation.
2. Tap **Reply**, **Reply to all**, or **Forward**.



3. Do one of the following:

- If you selected **Reply** or **Reply to all**, enter your reply message.
- If you selected **Forward**, specify the message recipients.

4. Tap **Send**.

### Muting a conversation

If you're part of a long message conversation that isn't relevant, you can 'mute' the conversation to keep all future additions out of your Inbox.

While viewing the message thread, press MENU and then tap **More > Mute**.



### Reporting a conversation as spam

The Gmail/Google Mail webmail service works hard to prevent spam (unwanted and unsolicited "junk" mail) from reaching your Inbox. But when spam makes it through, you can help improve the service by reporting the conversation as spam.

While viewing the message thread, press MENU, and then tap **More > Report spam**.



## Sending a message

1. Press HOME , and then tap  > Gmail/Google Mail.
2. In the Inbox, press MENU and then tap **Compose**.
3. Enter the message recipient's email address in the **To** field. If you are sending the email to several recipients, separate the email addresses with a comma. You can add as many message recipients as you want.  
As you enter email addresses, any matching addresses from your contacts list are displayed. Tap a match to enter that address directly.

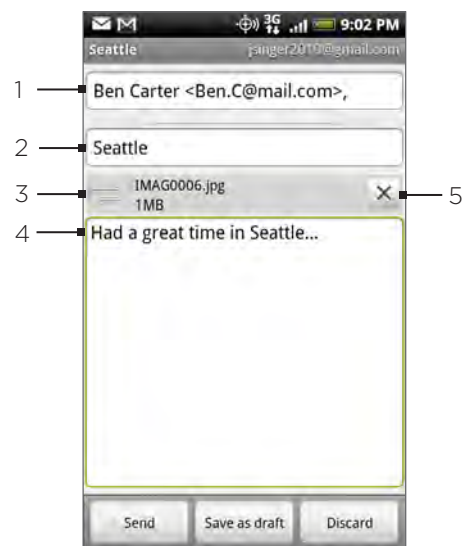

 If you want to send a carbon copy (Cc) or a blind carbon copy (Bcc) of the email to other recipients, press MENU and then tap **Add Cc/Bcc**.

4. Enter the email subject, and then compose your email.
5. If you want to add a picture attachment, press MENU and then tap **Attach**. Navigate to the picture you want to attach, and then tap the picture.



- 
- 1 Recipient.
  - 2 Subject.
  - 3 Attachment.
  - 4 Enter your message here.
  - 5 Tap to remove the attachment.
- 

6. After composing your message, tap **Send**.

 While composing the message, tap **Save as draft** or press BACK  to save it as a draft. To view your draft email messages, in the Inbox, press MENU and then tap **View labels > Drafts**.

## Adding a signature to your messages

You can add a signature to email messages that you send.

1. In the Inbox, press MENU and then tap **Settings > Signature**.
2. Enter your signature in the text box, and then tap **OK**.

 You can create a signature consisting of multiple lines of text. At the end of each line of text, tap  on the onscreen keyboard to create another line.



## Viewing your sent messages

In the Inbox, press MENU and then tap **View labels > Sent**.

## Managing conversations and messages

### Searching for messages

You can search for messages that contain one or more words in their contents or in their addresses, subjects, labels, and so on. When you search for messages, all of the messages in your Gmail/Google Mail account on the web are included (except those labeled Trash or Spam), not just those that you've synchronized onto your phone.

1. In the Inbox, press SEARCH .
2. Enter the word or words to search for.
3. Tap , or tap the Enter key on the onscreen keyboard.

A conversation list opens, displaying all of the conversations with messages that contain the words you searched for. The words you searched for are displayed in the title bar. You work with the conversations in this list just as you would with the conversations in your Inbox or any other conversation list.

### Starring a message

You can star an important message so that you can easily find it again. Conversations with starred messages are displayed with a star in your Inbox and other conversation lists. To view just conversations with starred messages, see “Viewing conversations by label” in this chapter.

Do one of the following:

- While reading a message, touch the star in its header.
- When viewing a conversation, touch its star to start the newest message in the conversation.

To unstar a message, touch its star again. You can also touch a star in a conversation list to unstar all messages in the conversation.

### Labeling a conversation

You can organize conversations by labeling them. Gmail/Google Mail has several preset labels you can use, and you can also add your own labels, using Gmail/Google Mail on the web.

1. While viewing the messages in a conversation, press MENU and then touch **Change labels**.
2. Select the labels that you want to assign to the conversation, and then tap **OK**.



### Viewing conversations by label

You can view a list of the conversations that have the same label.

1. When viewing your Inbox or another conversation list, press MENU, and then touch **View labels**.
2. Touch a label to view a list of conversations with that label.

The conversation list resembles your Inbox, but the label replaces “Inbox” in the title bar. You work with labeled conversations lists in the same way as with your Inbox.

## Changing Gmail/Google Mail synchronization settings

1. Press HOME , and then tap  > Gmail/Google Mail.
2. Press MENU, and then tap Settings > Labels.
3. To set the number of days to synchronize, tap Number of days to sync.
4. To set synchronization for a particular label, tap the label. You can select to synchronize the default number of days, or you can sync all or none of the label's messages.

## Working with conversations in batches

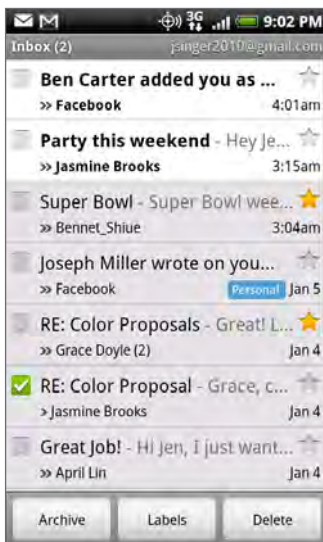

You can archive, label, delete, or perform other actions on a batch of conversations at once, in your Inbox or in another labeled list of conversations.

1. In the Inbox or other conversation list, select the check boxes for the conversations you want to work with as a batch. When you select a check box, the **Archive**, **Labels**, and **Delete** buttons are displayed at the bottom of the screen.



2. Tap the Archive, Labels, or Delete button to perform one of those actions on the batch of conversations, or press MENU for more options.

## Changing Gmail/Google Mail settings



1. Press HOME , and then tap  > Gmail/Google Mail.
2. In the Inbox, press MENU and then tap **Settings**.
3. Set the following options:
  - **Signature.** Tap to enter a signature that is appended at the end of your emails.
  - **Confirm delete.** Select the check box to show a confirmation box when you delete a conversation.
  - **Batch operations.** When selected, this adds a check box to the left of each conversation so you can add it to a batch. See “Working with conversations in batches” above.
  - **Clear search history.** Remove the searches you have performed.
  - **Labels.** Tap to select how many days and which Gmail/Google Mail labels to synchronize.
  - **Email notifications.** Select the check box to show a notification icon on the status bar when you receive a new email.
  - Tap **Select ringtone** if you want your phone to play a notification sound when a new email message arrives. On the ringtone menu, select a ringtone specific to new email messages. The ringtone plays briefly when selected. If you don't want a ringtone to play when you receive a new email message, tap **Silent**. To confirm your ringtone selection, tap **OK**.
  - Select **Vibrate** if you want your phone to vibrate when you receive a new email message.

# Mail



The Mail application lets you send and receive email from your webmail or other accounts, using POP3 or IMAP.

It also lets you access your Exchange ActiveSync email and other features on your phone. For information on this, see “Exchange ActiveSync email” in this chapter.

## Adding a POP3/IMAP email account

1. Press HOME , and then tap  > Mail.
2. Do one of the following:
  - If this is your first time to add an email account in Mail, tap **Other (POP3/IMAP)** on the **Choose a mail provider** screen.
  - If you have already added an email account in Mail, tap  on the upper-left corner, and then tap **New Account**. If the **Choose a mail provider** screen is displayed, tap **Other (POP3/IMAP)**.
3. Enter the **Email address** and **Password** for the email account and then tap **Next**.  
If the account type you want to set up is not in the phone database, you will be asked to enter more details.
4. Enter the **Account name** and **Your name** and then tap **Finish setup**.

## Viewing your email inbox

1. Press HOME , and then tap  > Mail.
2. Tap a tab at the bottom of the screen to filter the inbox.



- 
- 1 Tap to view a different email account or add a new email account.
  - 2 Filter tabs. See “Inbox filter tabs” for details.
  - 3 Marked (Exchange ActiveSync only)
  - 4 Meeting invitation (Exchange ActiveSync only)
  - 5 Number of unread email messages.
-

## Inbox filter tabs



### Received

Displays email messages as individual items.



### Conversations

Displays messages as conversations, grouped according to the subject line. Tap a subject in the list to show the email conversation.



### VIP group

Displays messages from contacts in your VIP group. To add contacts to the VIP group from this tab, tap **Add contact to group**, select the contacts you want to add, and then tap **Save**. For more information on contact groups, see “Contact groups” in the People chapter.



### Unread

Displays unread messages.



### Marked (Exchange ActiveSync only)

Displays all flagged messages.



### Meeting invitations (Exchange ActiveSync only)

Displays meeting invitations which you have not yet accepted or declined.



### Attachments

Displays all messages that have attachments.

## Refreshing an email account

Whatever your automatic synchronization settings are, you can also synchronize your sent and received emails manually at any time.

While in the account you want to synchronize, press MENU, and then tap **Refresh**.

## Sorting email messages

1. On the email account Inbox, press MENU, and then tap **Sort**.
2. Select from the options to sort email messages by date received, priority, subject, sender, or size.

## Deleting an email message

1. On the email account Inbox, press and hold the message you want to delete.
2. On the options menu, tap **Delete**.

## Deleting multiple email messages

1. On the email account Inbox, press MENU and then tap **Delete**.
2. Select the messages you want to delete, and then tap **Delete**.



## Exchange ActiveSync email

If you synchronize your phone with your work Exchange ActiveSync account, you can read, manage, and send email in the same easy way as with a POP3/IMAP account. However, you can also access some powerful Exchange features.



For information on setting up an Exchange ActiveSync account, see “Synchronizing with a Microsoft Exchange ActiveSync account” in the Accounts and sync chapter.

### Setting out of the office status

You can set your Out of Office status and auto-reply message right from your phone.

1. Press HOME , and then tap  > Mail.
2. Switch to the Exchange ActiveSync account.
3. Press MENU and then tap **More > Out of the office**.
4. Tap the field below **I am currently**, and then select **Out of the office**.
5. Set the dates and times for the period when you will be out of the office.
6. Enter the auto-reply message.
7. Tap **Save**.

### Sending a meeting request

1. Press HOME , and then tap  > Mail.
2. Switch to the Exchange ActiveSync account.
3. Press MENU and then tap **More > New meeting invitation**.
4. Enter the meeting details, and then tap **Send**.



### Setting the priority for an email message

You can set the priority for an email message you send with your Exchange ActiveSync account.

1. While composing the message, press MENU.
2. Tap **Set priority**.
3. Select the priority for the message.

If you selected High or Low priority, the priority appears below the subject line of the message.

## Composing and sending an email message

1. Press HOME , and then tap  > Mail.
2. On the email account Inbox, press MENU and then tap **Compose**.
3. Fill in one or more recipients. You can:
  - Enter email addresses directly in the To field. If you're sending the email to several recipients, separate the email addresses with a comma. As you enter email addresses, any matching addresses from your contacts list are displayed. Tap a match to enter that address directly.
  - Tap the  icon, and then select the contacts to whom you want to send the message. You can also select contact groups as recipients, or add contacts from the company directory if you have set up an Exchange ActiveSync account on your phone. When you have selected all the message recipients, tap **Done**.



If you want to send a carbon copy (Cc) or a blind carbon copy (Bcc) of the email to other recipients, press MENU, and then tap **Show Cc/Bcc**.





4. Enter the subject, and then compose your message.
5. To add an attachment, press MENU, tap **Add attachment**, and choose from the following options:
  - **Picture**. Select **Camera** to take a photo and attach it, or **Pictures** to attach a photo from your storage card.
  - **Video**. Select **Camcorder** to capture a video and attach it, or **Videos** to attach a video from your storage card.
  - **Audio**. Select **Voice Recorder** to make a voice recording and attach it, or **Files** to attach a music file or voice recording from your storage card.
  - **Location**. You can attach location information. Send your current location (requires GPS to be turned on), a location stored in Footprints, or a location you pick on a map. For more information about GPS, maps, and Footprints, see the Maps and location chapter.
  - **Document**. Attach a PDF file or an Office document such as a text file or a spreadsheet.
6. Tap **Send** to send the message immediately, or tap **Save as draft** if you want to send it later.



To open a draft email, in the email account Inbox, press MENU, and then tap **Folders > Drafts**.





## Viewing and replying to an email message

1. Press HOME , and then tap  > Mail.
2. On the email account Inbox, tap the email you want to view.  
For an Exchange ActiveSync account, you can mark an email. To mark an email, while viewing an email, tap the white flag  on the upper-right corner of the screen. The flag turns red  when you mark the message.
3. Tap Reply or Reply all to reply to the email.





You can copy, look up, translate, or share text from an email message. For information on how to do this, see “Copying text, looking up information, and sharing” in the Internet chapter.

## Editing email account settings

1. Press HOME , and then tap  > Mail.
2. Switch to the email account you want to edit.
3. Press MENU and then tap More > Settings.
4. Select from the following settings:
  - Account settings**  
Change the email account settings such as the name, email address, password, and description.
  - General settings**  
Set the font size when reading emails, enable, disable or set the signature, set the account as the default email account, and set where to save email attachments.
  - Send & receive**  
Set the maximum email file size limit when receiving and frequency to check for new emails and how many to check for. You can also set to have emails that you send bcc'd to yourself.
  - Notification settings**  
Set email notification settings.
  - Delete account**  
Tap to delete the email account.
5. Press BACK  to save your changes.

## Deleting an email account

1. Press HOME , and then tap  > Mail.
2. Switch to the email account you want to delete.
3. Press MENU, and then tap More > Settings > Delete account.

## Adding the Mail widget

Add the Mail widget to let you view your POP3/IMAP or Exchange ActiveSync emails on the Home screen. To learn how to add widgets, refer to “Adding a widget to your Home screen” in the Personalizing chapter.

# Calendar

## About Calendar

---

Use your phone's **Calendar** to create and manage your events, meetings, and appointments. You can also set up your phone to stay in sync with the following types of calendars:

- On your phone, sign in to your Google Account so you'll be able to sync your phone's Calendar with your Google Calendar online. If you have not signed in to your Google Account yet, see the Accounts and sync chapter to find out how to sign in.



You can create multiple Google Calendars only in Google Calendar on the Web. After creating them in Google Calendar on the Web, you'll be able to see them in the Calendar application on your phone.

For more information about creating and managing multiple Google Calendars, visit the Google website at the following URL: <http://calendar.google.com>.

- If you're using Microsoft Outlook on your computer, you can set up HTC Sync on your computer to sync Outlook Calendar with your phone's Calendar. See "Using HTC Sync" for details.
- If you have a Microsoft Exchange ActiveSync account and you have added it on your phone, you can sync your phone's Calendar with your Exchange ActiveSync calendar events. See the Email and Accounts and sync chapters for details.

## Creating a calendar event

---

You can create events that appear on your phone only, as well as events that sync with your Google Calendar, your computer's Outlook Calendar, or Exchange ActiveSync calendar.

1. Press HOME , then tap , and then tap **Calendar**.
2. On any Calendar view, press MENU and then tap **New event**.



When you are in the Month or Agenda view, you can also tap  at the bottom-right of the screen to create a new event.

3. If you have more than one calendar, select a calendar in which to add the event:
  - Select **My Calendar** to create an event that will appear only on your phone.
  - Select your Google Account to create a Google Calendar event. If you have several Google Calendars on the Web, select one in which to add your event.
  - Select **PC Sync** to create an Outlook Calendar event to sync with your computer.
  - Select **Exchange** to create an Exchange ActiveSync calendar event.
4. Enter a name for the event.
5. To specify the date and time of the event, do one of the following:
  - If there is a time frame for the event, tap the **From** and **To** date and time to set them.
  - If it is a special occasion such as a birthday or a whole-day event, set the **From** and **To** date, then select the **All day** check box.
6. Enter the event location and description.

7. Set the reminder time.



You can add another reminder time in a Google Calendar event. Press MENU and then tap **Add reminder**.

8. If the event occurs on a regular basis, tap the **Repetition** box and then choose how often the event occurs.
9. Scroll to the bottom of the screen and then tap **Save**.

## Inviting guests to your event (Google Account only)

If you want to invite guests to your event, you need to create and add the event in your Google Calendar. An invitation email will be sent to your guests using your Google Account.

1. Open Calendar and create a new event. Tap the **Calendar** field and then select your Google Account (or one of your other Google Calendars). For the steps, see “Creating a calendar event”.
2. Add details about the event, such as date and time, location, and more.
3. In the **Guests** field, enter the email addresses of everyone you want to invite to the event. Separate multiple addresses with commas ( , ).

If the people to whom you send invitations use Google Calendar, they’ll receive an invitation in Calendar and by email.

4. Tap **Save** to add the event to your Google Calendar.

## Sending a meeting request using Calendar (Exchange ActiveSync only)

If you have an Exchange ActiveSync account set up on your phone, you can use Calendar to create a meeting appointment and send a meeting request email to the people you want to invite to your meeting.

1. Open Calendar and create a new event. Tap the **Calendar** field and then select **Exchange**. For the steps, see “Creating a calendar event”.
2. Add details about the meeting, such as date and time, location, and more.
3. Press MENU and then tap **Meeting Invitation**.
4. Tap  and choose attendees from your contacts or Company Directory.
5. Enter your message and then tap **Send**.
6. Tap **Save** to add the meeting appointment to your Exchange ActiveSync Calendar.

## Changing calendar views

---



When you open Calendar, it displays the Month view by default. You can also display the Calendar in Agenda, Day, or Week view. To change between calendar views, press MENU, and then choose the type of view that you want.

### Month view

In Month view, you'll see markers on days that have events.



When in Month view:

- Tap  on the bottom left of the screen to switch to Agenda view. Tap  on the bottom right to create a new event.
- Tap a day to view the events of that day.
- Press and hold a day to open an options menu from which you can also choose to create an event or switch to either Day or Agenda view.
- Slide your finger up or down the screen to view earlier or later months.

## Day and Agenda views

Day view displays a list of the events of one day and also shows weather information at the bottom of the screen when you're viewing events of the current day. Agenda view shows a list of all your events in chronological order.

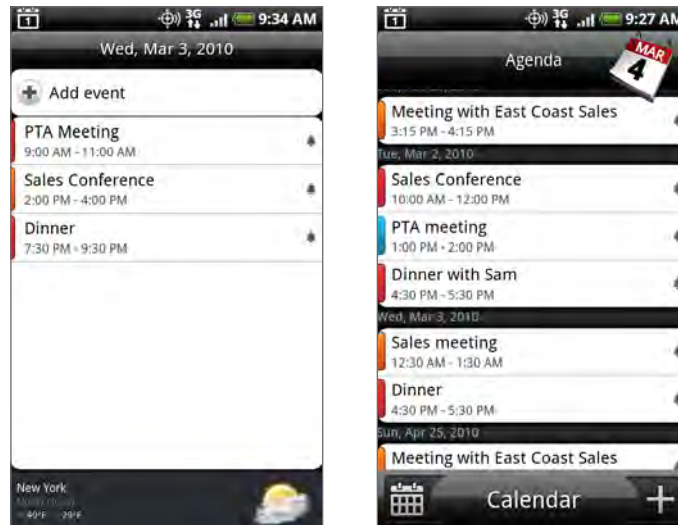

The color bars on the left side of the events indicate the type of calendar in which the event is part of. To find out what each color represents, press MENU and then tap **More > Calendars**.

When in Day view, slide left or right across the screen to view earlier or later days.



- In Day view, the weather information appears only if the event is within the five-day forecast of the Weather application.
- Weather information does not appear in Day view when you change Day view to display as a time list. See “Changing Calendar settings” for details.

## Week view

Week view displays a chart of the events of one week.

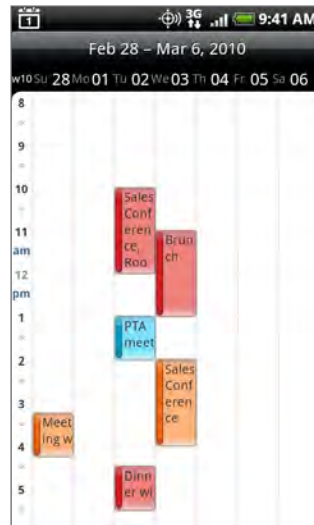

When in Week view:

- You can press and hold on a time slot to create a new event at that time.
- Tap an event to view its details.
- Slide left or right across the screen to view earlier or later weeks.





In a crowded Week view, it may be easier to select an event by using the optical joystick. Then press the optical joystick to view details about the selected event.

## Viewing, editing or deleting an event

---

You can view, edit, or delete events you created. You can also view event invitations that other people sent to you.

### Viewing and editing an event

1. Press HOME , then tap , and then tap **Calendar**.
2. In Month view, tap the day when the event takes place, and then tap the event to open it. The Event details screen then opens and shows the summary of the event.
3. When viewing the event summary, you can do the following:
  - Find the event's location in Maps.
  - If it's a Google Calendar or Exchange ActiveSync calendar event, check the participants of the event.
  - Change the reminder time.
  - If it's a Google Calendar event, respond whether you'll attend the event.
  - Press the BACK  button on your phone to save changes you made on the Event details screen.
4. To edit more details about the event, press MENU while you're on the Event details screen and then tap **Edit event**.
5. Make your changes to the event.
6. When you're done editing, scroll down to the bottom of the screen and then tap **Save**.

### Deleting an event

There are a number of ways to delete an event.

- While viewing the summary of an event on the Event details screen, press MENU and then tap **Delete event**.
- In Day, Agenda or Week view, press and hold an event and then tap **Delete event**.
- When editing an event, scroll down to the bottom of screen and then tap **Delete**.

If the event repeats, you'll be asked whether you want to delete just that occurrence, this and all future occurrences, or all past and future occurrences in your Calendar.

## Calendar event reminders

---

If you have set at least one reminder for an event, the upcoming event icon  will appear in the notifications area of the status bar to remind you of the upcoming event.

### Viewing, dismissing, or snoozing event reminders

1. Tap the status bar, then slide your finger down the screen to open the Notifications panel.
2. Do one of the following:
  - Tap **Clear** to dismiss event reminders and all other notifications. Other types of notifications such as new messages and missed calls will also be deleted.
  - After sliding open the Notifications panel, tap the calendar event reminder. You'll then see a list of all pending event reminders. Tap **Snooze all** to snooze all event reminders for five minutes, or tap **Dismiss all** to dismiss all event reminders.
  - Press **BACK**  to keep the reminders pending in the notifications area of the status bar.



# Displaying and synchronizing calendars

---

You can select which calendars to show or hide on your phone's Calendar, and which ones to keep synchronized.

## Showing or hiding calendars

In any Calendar view, press MENU , tap **More > Calendars**, and then select or clear a calendar to show or hide it. Tap **All calendars** to display all calendars.

The calendars are kept synchronized on your phone, whether or not you hide them.

## Choosing which Google Calendars are synchronized on your phone

You can choose which Google Calendars to keep synchronized on your phone or which ones to stop synchronizing.

### Stop synchronizing a Google Calendar

1. In any Calendar view, press MENU and then tap **More > Calendars**.
2. Press MENU again and then tap **Remove calendars**.
3. Select a Google Calendar to remove from your calendars list, and then tap **OK**.
4. Press **BACK**  to update Calendar with the new changes and return to the Calendar view you were viewing.

The calendars that you remove from your calendars list will no longer be synchronized on your phone, but you remain subscribed to them and can work with them in Google Calendar on the Web.

### Adding a Google Calendar to sync with

Only the calendars that you've created or subscribed to on the Web, but previously removed from your calendars list, are shown in the list of calendars that you can add.

1. In any Calendar view, press MENU and then tap **More > Calendars**.
2. Press MENU again and then tap **Add calendars**.
3. Select a Google Calendar to add to your calendars list, and then tap **OK**.
4. Press **BACK**  to update Calendar with the new changes and return to the Calendar view you were viewing.

## Changing Calendar settings

---

You can change Calendar's settings to specify how it displays events and how it notifies you of upcoming events. In any Calendar view, press MENU and then tap **More > Settings** to access Calendar's settings.

### Reminder settings

Choose how you want Calendar to issue event reminders when there are upcoming events.

#### All calendars

Select this check box to use the same event reminder settings for all types of calendars. If you clear this check box, you can set different reminder settings for each calendar.

#### Set alerts & notifications

Configure event reminders to open an alert, send you a notification, or turn off event notifications on your phone.

#### Default reminder time

Choose how soon before an event you want to be notified.

#### Select ringtone

Choose a ringtone to sound when you receive an event reminder.

#### Vibrate

Choose whether you want your phone to vibrate when you receive an event notification.

#### Hide declined events

Choose whether to show or hide events to which you've declined invitations.

### Calendar view settings

Choose what appears in Calendar when opened and what's shown in Day, Week, and Month views.

#### Start in

Choose the default Calendar view that is displayed when you open Calendar.

#### Day views

Choose whether to display Day view in the form of an event list or time list.

#### First day of week

Set the Month and Week views to start on a Sunday or Monday.

#### Include weather

Make sure this check box is selected so that weather information is shown in Day view's event list.



#### City

By default, Day view displays your current location's weather. You can change it to display the weather of another city.

## Sending a vCalendar

---

You can send a calendar event as a vCalendar to someone's phone or your computer using Bluetooth. You can also send it as a file attachment with your message.

1. Press HOME , tap , and then tap **Calendar**.
2. In Month view, tap the day when the event takes place.
3. Press and hold the calendar event you want to send, and then tap **Share vCalendar**.
4. Choose whether to send the event using Bluetooth or send it by email.
5. If you chose to send using Bluetooth, in the next few steps, you'll be asked to turn on Bluetooth on your phone and connect to the receiving Bluetooth device so the vCalendar can be sent. Follow the steps in "Sending information from your phone to another device" in the Bluetooth chapter.

If you chose to send by email, a new message window opens and automatically includes the vCalendar as an attachment. Your default email account that's selected in the Mail application will be used to send. For more information about using the Mail application, see the Email chapter.



You can also choose to send the vCalendar in a multimedia message. For more information about sending a multimedia message, see the Messages chapter.

## About the Calendar widget

---

There's a **Calendar** widget available that you can add to your Home screen, and it comes in different calendar views. Tapping a day or event on the widget brings you to the Calendar application.

To find out how you can add a widget, see "Personalizing your Home screen with widgets" in the Personalizing chapter.

# Clock and Weather

## About the HTC Clock widget

---

The HTC Clock widget that's by default added on the Home screen shows your current date, time, and location. You can tap the weather image on this widget to open the Weather application and check for more weather forecasts. See “Checking weather” for details.





The HTC Clock widget comes in a variety of looks and designs. You can add another clock widget to the extended Home screen, if you want to have another clock that shows the time of another city. To find out how you can add a widget, see “Personalizing your Home screen with widgets” in the Personalizing chapter.

## About the Clock application

---

The **Clock** application is more than just a regular date and time clock. It functions as a desk clock that shows the date, time, and weather information, and it can turn into a night clock or screensaver. It has a world clock that shows you the current time in several locations across the globe. There's also an alarm clock, stopwatch, and countdown timer.

To open the Clock application:

- Press HOME  and then tap the HTC Clock widget on the Home screen.
- You can also press HOME , tap , and then tap **Clock**.

Tap the tabs at the bottom row or slide your finger across the tabs to switch between the different functions of the Clock application.





- 
- 1 Desk Clock tab
  - 2 World Clock tab
  - 3 Alarm Clock tab
  - 4 Stopwatch tab
  - 5 Timer tab
-

## Using Desk Clock

Opening the Clock application brings you directly to the Desk Clock screen.

The Desk Clock displays the current date, time, and weather, an alarm clock indicator, and a battery charging indicator. You can dim the screen to show only the time and date on the Desk Clock.



- 1 The alarm clock indicator shows whether the alarm clock is on or off. To find out how to turn on and set the alarm clock, see "Setting the alarm clock".
- 2 Below the date and time, you'll see the weather information of your current location. Tapping the weather information brings you to the Weather application where you can see weather forecasts of the next few days. See "Checking weather" for more information about the Weather application.
- 3 The battery charging indicator shows the battery charge level. You'll see it only when your phone is plugged with the power adapter or connected to your computer.
- 4 Tap this button to dim the screen and display only the time and date on the Desk Clock. To light up the screen again, tap anywhere on the screen or press the BACK  button on your phone.
- 5 Tap this button to dim the screen and go into screensaver mode. When in screensaver mode, the time and date will change position on the screen after every few minutes. To light up the screen again, tap anywhere on the screen or press the BACK  button on your phone.

You can change the Desk Clock screen to display the date and time of another time zone. To find out how to select a different time zone, see "Setting the time zone, date, and time".

## Using World Clock

Use the Clock application's World Clock screen to check the current time in several places around the globe simultaneously. You can also set your home city, add more cities to the world clock list, and manually set your time zone, date, and time.

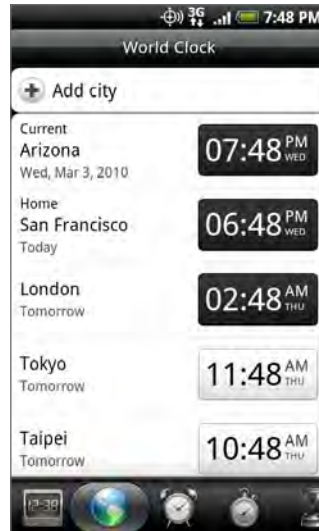

### Setting your home city

1. Press HOME  and then tap the HTC Clock widget on the Home screen.
2. Tap the World Clock tab.
3. Press MENU and then tap Home settings.
4. Enter your home city's name. As you enter letters, the list is filtered to show matching cities and countries.
5. Scroll through the list and tap your home city.

### Setting the time zone, date, and time

To set the time zone, date, and time on your phone manually, you need to turn off auto time synchronization first.

1. Press HOME  and then tap the HTC Clock widget on the Home screen.
2. Tap the World Clock tab.
3. Press MENU and then tap Local time settings to open the Date & time settings screen.
4. Clear the Automatic check box.
5. Tap Select time zone. Scroll through the list and then tap the time zone that you want.
6. To change the date, tap Set date. Adjust the date by rolling the day, month, and year scroll wheels onscreen and then tap OK.
7. To change the time, tap Set time. Adjust the time by rolling the hour and minute scroll wheels onscreen and then tap OK.
8. Tap the Use 24-hour format check box to toggle between using a 12-hour or a 24-hour time format.

9. Tap **Select date format** then select how you want dates to be displayed. (The selected date format also applies to the date displayed in the alarm clock.)



You can also press HOME  > MENU and then tap **Settings > Date & time** to open the Date & time settings screen.

## Adding a city to the World Clock screen

Add more cities to the World Clock screen so you can instantly check the date and time in these cities. In addition to the current and home cities, the World Clock screen can display up to 15 cities.

1. Press HOME  and then tap the HTC Clock widget on the Home screen.
2. Tap the **World Clock** tab.
3. Tap **Add city**. Enter the city name you want to add. As you enter letters, the list is filtered to show matching cities and countries.
4. Scroll through the matching list and tap the city that you want to add.



## Setting the alarm clock

You can use the Clock application's Alarms screen to set up one or more wake-up alarms.

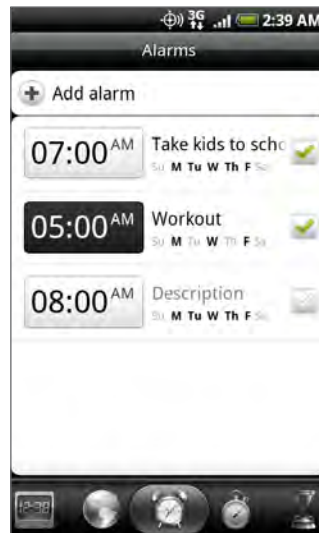

### Setting an alarm

1. Press HOME  and then tap the HTC Clock widget on the Home screen.
2. Tap the Alarms tab.
3. Select the check box of an alarm, and then tap that alarm.
4. On the Set alarm screen, drag your finger up or down to roll the time scroll wheels and set the alarm time.
5. Scroll through the Set alarms screen to see all the available alarm options. You can:
  - Enter the alarm **Description** and choose the **Alarm sound** to use.
  - Tap **Repeat**. Select what days of the week to sound the alarm and then tap **OK**.
  - Select the **Vibrate** check box if you want your phone to also vibrate when the alarm goes off.
6. When you've finished setting the alarm, tap **Done**.



- To turn off an alarm, tap to clear the check box of the alarm.
- If you need to set more than three alarms, press MENU while you're on the Alarms screen and then tap **Add alarm**.

### Deleting an alarm

1. Press HOME  and then tap the HTC Clock widget on the Home screen.
2. Tap the Alarms tab.
3. On the Alarms screen, press MENU and then tap **Delete**.
4. Select the alarms you want to delete and then tap **Delete**.

## Changing alarm sound settings

If you've set one or more alarms, you can change their settings such as the alarm volume, how long to snooze the alarm, and more.

1. Press HOME  and then tap the HTC Clock widget on the Home screen.
2. Tap the **Alarms** tab.
3. On the **Alarms** screen, press MENU and then tap **Settings**. You can change the following settings:

### Alarm in silent mode

This option is selected by default, which allows the alarm to sound even when your phone's volume is set to silent mode. Clear this check box if you want to silence the alarm when the volume is in silent mode.

### Alarm volume

Set the volume level that you want for the alarm.

### Snooze duration

Set how long to snooze between alarms.

### Side button behavior

Choose what happens to the alarm when pressing the side button (VOLUME UP/DOWN) of your phone. You can set the button to snooze, dismiss the alarm, or disable the button.

The side button works only when the phone's screen is not locked. While on the lock screen, tap the onscreen **Snooze** button to snooze, or slide down the screen to dismiss the alarm.

## Checking weather

If you consented to turn location service on when you were setting up your phone for the first time, you'll see the weather of your current location right on the HTC Clock widget of your Home screen.

You can also use the Weather application to check the current weather and weather forecasts for the next four days of the week. In addition to your current location's weather, this application also displays the weather forecasts of other cities around the globe.



If you declined to turn location service on during first-time setup of your phone, turn location service on in your phone's settings so that you'll be able to check your current location's weather on the HTC Clock widget, Weather application, and the Weather widget. Press HOME > MENU, tap **Settings** > **Location**, and then select the **Use wireless networks** check box.

1. Connect to the Internet using your phone's Wi-Fi or data connection. To find out how, see the Internet chapter.
2. Press HOME , tap , and then tap **Weather**.
3. On the Weather screen, you'll first see your current location's weather. To check the weather in other cities, swipe your finger up or down the screen.

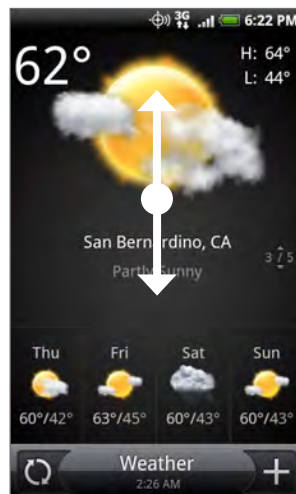



4. The Weather application automatically downloads and displays the latest weather updates. You can also download the most recent weather anytime by tapping .
5. To see more weather details on the Web, tap **Weather** at the bottom center of the Weather screen.

### Adding a city to the Weather screen



Add more cities to the Weather screen so you can instantly check the weather forecasts in these cities. In addition to your current location, the Weather screen can display up to 15 cities.

1. Press HOME , tap , and then tap **Weather**.
2. On the Weather screen, tap .
3. Enter the location you want to add on the text field. As you enter text, the list is filtered to show the possible locations based on the letters you entered.
4. Tap the desired city to select it.



## Changing the order of cities on the Weather screen

1. Press HOME , tap , and then tap **Weather**.
2. On the Weather screen, press MENU and then tap **Rearrange**.
3. Press and hold  at the end of the item you want to move. When the row is highlighted in green, drag it to its new position, then release.
4. Tap **Done**.

## Deleting cities from the Weather screen

1. Press HOME , tap , and then tap **Weather**.
2. On the **Weather** screen, press MENU and then tap **Delete**.
3. Select the cities you want to remove and then tap **Delete**.

## Changing weather options

1. Press HOME , tap , and then tap **Weather**.
2. On the **Weather** screen, press MENU and then tap **Settings**.
3. You can change the following weather settings:
  - Select or clear the **Update automatically** check box, depending on whether you want your phone to automatically download weather updates.
  - To set an auto update schedule, tap **Update frequency** and choose a schedule.
  - Tap **Temperature scale** to choose whether to display weather in Celsius or Fahrenheit.

## About the Weather widget

---

Use the **Weather** widget to instantly check weather forecasts of your current location and other cities without having to open the Weather application.

The Weather widget comes in different looks and styles. You can add this widget to the Home screen, if it's not yet added. To find out how you can add a widget, see "Personalizing your Home screen with widgets" in the Personalizing chapter.

# Internet

## Data connection

---

Settings for connecting to the Verizon data network are already preconfigured on your device, and your device is ready to connect to the Internet.

### Turning the data connection on or off

Turning your data connection off can help optimize your battery life. It can also save money on data charges. However, when your data connection is turned off, you may not always receive automatic updates to your email, social network accounts, and other synchronized information.

1. Press HOME  > MENU and then tap **Settings > Wireless & networks**.
2. Select the **Mobile network** check box to turn on the data connection; clear the check box to turn off the data connection.

### Enabling data roaming

Data roaming lets you connect to Verizon Wireless's partner networks and access data services when you are out of Verizon Wireless's coverage area.

1. Press HOME  > MENU and then tap **Settings > Wireless & networks**.
2. Tap **Mobile networks** and then select the **Data roaming** check box.

 Accessing data services while roaming may incur significant charges. Inquire about the data roaming tariffs with Verizon Wireless before enabling data roaming.

## Wi-Fi

---

Wi-Fi provides wireless Internet access over distances of up to 300 feet (100 meters). To use Wi-Fi on your phone, you need access to a wireless access point or “hotspot”.



The availability and range of the Wi-Fi signal depends on the number, infrastructure, and other objects through which the signal passes.

### Turning Wi-Fi on and connecting to a wireless network

1. Press HOME > MENU, and then tap **Settings > Wireless controls**.
2. Select the **Wi-Fi** check box to turn Wi-Fi on. The phone will scan for available wireless networks.
3. Tap **Wi-Fi settings**. The network names and security settings of detected Wi-Fi networks are displayed in the Wi-Fi networks section.
4. Tap a Wi-Fi network to connect. If you selected an open network, you will be automatically connected to the network. If you selected a network that is secured with WEP, enter the key and then tap **Connect**.

Depending on the network type and its security settings, you may also need to enter more information or choose a security certificate.

When your phone is connected to a wireless network, the Wi-Fi icon appears in the status bar and tells you the approximate signal strength (number of bands that light up). If **Network notification** in Wi-Fi settings is enabled, this icon appears in the status bar whenever the phone detects an available wireless network within range.



The next time your phone connects to a previously accessed secured wireless network, you will not be prompted to enter the key or other security information again, unless you reset your phone to its factory default settings.

### Connecting to a Wi-Fi network with EAP-TLS security

You may need to install a network certificate (.p12) to your phone before you can connect to a Wi-Fi network with EAP-TLS authentication protocol.

1. Save the certificate file to the root folder of the storage card.
2. Press HOME > MENU, and then tap **Settings > Security**.
3. Tap **Install from SD card**.
4. Select the network certificate needed to connect to the EAP-TLS network.
5. Follow the steps in the previous section to connect to the Wi-Fi network.

## Checking the wireless network status

1. Press HOME  > MENU and then tap **Settings > Wireless & networks**.
2. On the Wireless & networks screen, tap **Wi-Fi settings**, and then tap the wireless network that the phone is currently connected to.

A message box is then displayed showing the Wi-Fi network name, status, speed, signal strength, and more.



 If you want to remove the wireless network settings on your phone, tap **Forget** on this window. You need to enter the settings again if you want to connect to this wireless network.

## Connecting to another Wi-Fi network

1. On the Wireless & networks screen, tap **Wi-Fi settings**. Detected Wi-Fi networks are displayed in the Wi-Fi networks section. To manually scan for available Wi-Fi networks, on the Wi-Fi settings screen, press MENU and then tap **Scan**.
2. Tap another Wi-Fi network to connect to it.

 If the wireless network you want to connect to is not in the list of detected networks, scroll down the screen, then tap **Add Wi-Fi network**. Enter the wireless network settings, and then tap **Save**.

## Adding the Data connection and Wi-Fi widgets

---

Add the Data connection and/or Wi-Fi widget to the Home screen to make it faster for you to turn on or off these connections. Tap the widget to turn on or off the connection.



To learn how to add widgets, refer to “Adding a widget to your Home screen” in the Personalizing chapter.



## Connecting to a virtual private network (VPN)

---

From your phone, you can add, set up, and manage virtual private networks (VPNs) that allow you to connect and access resources inside a secured local network, such as your corporate network.

### Preparing your phone for VPN connection

Depending on the type of VPN you are using at work, you may be required to enter your login credentials and/or install security certificates before you can connect to your company's local network. You can get this information from your network administrator.

Also, your phone must first establish a Wi-Fi or data connection before you can initiate a VPN connection. For information about setting up and using these connections on your phone, see "Data connection" and "Wi-Fi" in this chapter.

### Setting up secure credential storage

If your network administrator instructs you to download and install security certificates, you must first set up the phone's secure credential storage.

1. Press HOME  > MENU, tap **Settings** > **Security**, and then tap **Set password**.
2. Enter a new password (at least 8 characters without any spaces) for the credential storage, scroll down and confirm the password, and then tap **OK**.
3. Select the **Use secure credentials** check box.



You can then download and install the certificates needed to access your local network. Your network administrator can tell you how to do this.

### Adding a VPN connection

1. Press HOME  > MENU, and then tap **Settings** > **Wireless & networks** > **VPN settings**.
2. Tap **Add VPN**, and then tap the type of VPN you want to add.
3. Tap the VPN settings and set them up according to the security details you have obtained from your network administrator.
4. When finished, press MENU, and then tap **Save**.

The VPN is then added to the VPNs section of the VPN settings screen.

### Connecting to a VPN

1. Press HOME  > MENU, and then tap **Settings** > **Wireless & networks** > **VPN settings**.
2. In the VPNs section, tap the VPN that you want to connect to.
3. When prompted, enter your log in credentials, and then tap **Connect**.  
When you are connected, the VPN connected icon  appears in the notification area of the title bar.
4. Open the web browser to access resources such as intranet sites on your corporate network. See "Using your phone's web browser" for more information.

## Disconnecting from a VPN

1. Press and hold the title bar, and then slide down your finger to open the Notifications panel.
2. Tap the VPN connection to return to the VPN settings screen, and then tap the VPN connection to disconnect from it.

When your phone has disconnected from the VPN, the VPN disconnected icon  is displayed in the notification area of the title bar.

## Using your phone's web browser



Open the web browser to start surfing the web. The browser is fully optimized and comes with advanced features that let you enjoy Internet browsing on your phone.



You must have an active data connection or Wi-Fi connection to access the Internet.

### Opening the browser

Do one of the following:

- Press HOME , and then tap **Internet**.
- Press HOME , and then tap  > **Internet**.



### Going to a web page

1. On the browser screen, press MENU and then tap the URL field on top of the screen.
2. Enter the web page address using the keyboard. As you enter the address, matching web page addresses will appear on the screen. Tap an address to go directly to that web page or continue entering the web page address.



3. Tap the Enter key  on the onscreen keyboard.

### Setting your home page

1. Press HOME , and then tap  > **Internet**.
2. Press MENU, and then tap **More** > **Settings** > **Set home page**.
3. On the Set home page screen, select the home page you want to use.

### Changing the screen orientation

The phone automatically changes the screen orientation depending on how you are holding your phone.



The **Orientation** check box in HOME  > MENU > Settings > Sound & display needs to be selected for the screen orientation to automatically change.

### Browsing full versions of all web sites

Some web sites display a mobile version of their pages to phone web browsers. You can choose to view the full version of all pages, even for these sites.

1. Press HOME , and then tap  > **Internet**.
2. Press MENU, tap **More** > **Settings**, and then clear the **Mobile view** check box.

## Navigating on a web page

You can swipe your finger on the screen or the optical joystick to navigate and view other areas of the web page.

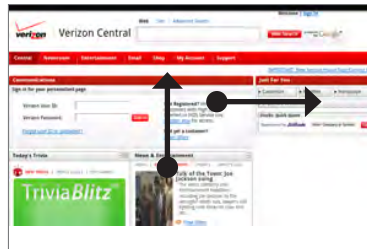

## Zooming in or out on a web page

Tap the screen twice quickly to zoom in, then tap the screen twice quickly again to zoom out. You can also use your fingers to pinch or spread the screen to zoom in and out.

Use your thumb and index fingers to 'spread' the web page to zoom in.

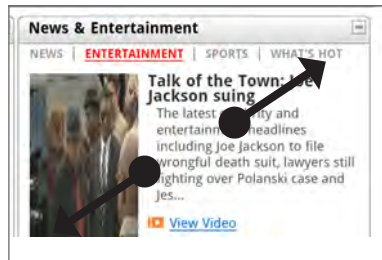

Use your thumb and index fingers to 'pinch' the web page to zoom out.

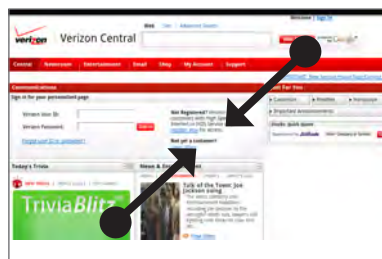

## Selecting a link in a web page

You can tap a link with your finger to open it, or press and hold a link for more options.

Link	What to do
Web page address (URLs)	<ul style="list-style-type: none"> <li>Tap the link to open the web page.</li> <li>Press and hold the link to open a menu that allows you to open, bookmark, copy to the clipboard, or share the link via email.</li> </ul>
Email address	<ul style="list-style-type: none"> <li>Tap to send an email message to the email address.</li> <li>Press and hold, then tap Copy on the menu to copy the email address to the clipboard. You can paste the email address later when creating a new contact or sending a new email message.</li> </ul>

The browser also recognizes some phone numbers and addresses that allow you to call the phone number or locate the address in Google Maps™. When you navigate to a recognized phone number or address, it is highlighted.

Link	What to do
Location address	Tap the address to open Google Maps and locate the address.
Phone number	Tap to open the phone dialer to call the phone number.

You can also navigate to a link on a web page and select it using the optical joystick. This is particularly useful when viewing text and links at a small size. Links are enclosed in a colored box when selected.



- 1 Link is selected.
- 2 Link is not selected.

After selecting a link with the optical joystick, you can press the optical joystick to open the link, or press and hold the optical joystick for more options.

## Opening a new browser window

Open multiple browser windows to make it easier for you to switch from one web site to another. You can open up to 4 browser windows.

1. While viewing a web page, press MENU and then tap Windows.
2. Tap the “+” button.

A new browser window opens and goes to the home page that is set.

## Switching between browser windows

1. While viewing a web page, press MENU and then tap Windows.
2. Select the browser window you want to view by sliding your finger on the screen from right to left.

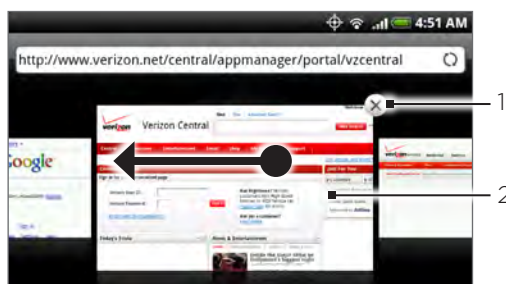

- 
- 1 Tap to close the web page.
  - 2 Tap to display the web page in full screen.
- 

## Finding text within a web page

1. While viewing a web page, press MENU and then tap **More > Find on page**.
2. Enter the search item. As you enter characters, matching characters will be highlighted. Tap the left or right arrow to go to the previous or next matching item.

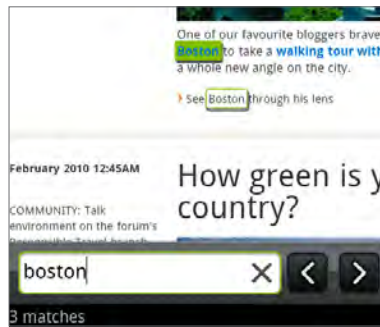

## Downloading applications from the web

Before you can download applications from the web, you must first enable downloading from the phone settings.

1. Press HOME  > MENU, and then tap **Settings > Applications**.
2. Select the **Unknown sources** check box.
3. When the Attention dialog box opens, tap **OK**.



All downloaded applications are saved to the storage card. Before you download an application from the web, make sure that you have installed a storage card on your phone. For information on how to install a storage card, refer to the Basics chapter.



Applications downloaded from the web can be from unknown sources. To protect your phone and personal data, download applications only from trusted sources such as Android Market. Refer to “Finding and installing apps from Android Market” in the More apps chapter for details.

## Viewing your downloads

While viewing a web page, press MENU and then tap **More > Downloads**.

## Copying text, looking up information, and sharing

You can select text and then:

- Copy it.
- Look it up on Wikipedia or Google Dictionary.
- Get a translation of the text from Google Translate.
- Share the text in a new email, text, or multimedia message or in your status update on a social network.

## Selecting text

1. Press and hold on a word.



To select text in a link, press and hold the link, and then tap **Copy text**.

2. Drag the start and end markers to highlight the surrounding text you want to select.



- 
- 1 Tap to copy, search/translate, or share the text.
  - 2 Start and end markers. Drag to increase or decrease the text selection area.
- 





When you select a larger block of text, the appearance of the markers changes. You can drag these markers up or down to select multiple paragraphs of text.



## Copying and pasting text

1. After you have selected the text you want to copy, tap . The selected text is then copied to the clipboard.
2. In a text entry field (for example while composing a message), press and hold at the point where you want to paste the text.
3. Tap **Paste**.

## Searching or translating text

1. After you have selected the text you want to search or translate, tap .
2. Tap one of the following tabs:
  -  **Wikipedia**. Look for related information on Wikipedia, based on the text that you selected.
  -  **Google Translate**. Translate the text to another language.
  -  **Google Dictionary**. Look up the selected text in the dictionary.

## Pasting text in a new message or social network status update

1. After you have selected the text you want to share, tap .
2. Select an option to paste the selected text in a new email, text or multimedia message or in your status update on a social network such as Twitter. See the Email, Messages, and Social chapters for more information on using these features.



## Viewing bookmarks and previously visited pages

You can store as many bookmarks as you want on your phone. You can also access a convenient History list of the sites you have visited, or quickly view the pages that you access most often.



### Bookmarking a web page

1. While viewing a web page, press MENU, and then tap **Add bookmark**. The New bookmark screen opens.
2. Edit the bookmark name if needed, and then tap **Done**.

### Opening a bookmark



1. Press HOME , and then tap  > **Internet**.
2. Press MENU, and then tap **Bookmarks**.
3. On the Bookmarks tab , navigate to the bookmark you want to open, and then tap it.

### Editing a bookmark



1. Press HOME , and then tap  > **Internet**.
2. Press MENU, and then tap **Bookmarks**.
3. On the Bookmarks tab , press MENU and then tap **Edit**.
4. Tap the bookmark you want to edit.
5. Enter your changes, and then tap **Done**.





### Viewing a previously visited page

1. Press HOME , and then tap  > Internet.
2. Press MENU, and then tap **Bookmarks**.
3. On the History tab , navigate to the page you want to view and then tap the page.



### Clearing the list of previously visited pages

1. Press HOME , and then tap  > Internet.
2. Press MENU, and then tap **Bookmarks**.
3. On the History tab , press MENU, and then tap **Clear history**.





### Viewing a page that you often visit

1. Press HOME , and then tap  > Internet.
2. Press MENU, and then tap **Bookmarks**.
3. On the Most Visited tab , navigate to the page you want to view, and then tap the page.

### Clearing the list of most visited pages



1. Press HOME , and then tap  > Internet.
2. Press MENU, and then tap **Bookmarks**.
3. On the Most Visited tab , press MENU, and then tap **Clear all**.

### Changing the view of bookmarks or most visited pages

1. Press HOME , and then tap  > Internet.
2. Press MENU, and then tap **Bookmarks**.
3. On the Bookmarks tab  or the Most visited tab , press MENU, and then tap **Thumbnails**, **List**, or **Grid** to change the view. For example, if you are in Thumbnails view and you want to view bookmarks in a grid, press MENU > **List**, and then press MENU > **Grid**.

## Setting browser options

Customize the web browser to suit your browsing lifestyle. Set display, privacy, and security options when using the web browser.

1. Press HOME , and then tap  > Internet.
2. Press MENU, and then tap **More** > **Settings**.

## Using your phone as a modem (tethering)

---

Get online with your notebook or desktop computer at any time, using your phone's data connection. For information on setting up and using the data connection, see "Data connection" earlier in this chapter.



You need to install HTC Sync before you can use your phone as a modem. Refer to "Using HTC Sync" in the Sync chapter for details.

1. Make sure your phone's data connection is turned on. See "Turning the data connection on or off" earlier in this chapter to learn how to turn on the phone's data connection.
2. Connect the phone to the computer using the provided USB cable.
3. On the Connect to PC screen, select **Mobile Broadband Connect**, and then tap **Done**.

When you are using your phone as a modem, the USB mass storage feature is disabled, and you are also not able to use HTC Sync.

# Bluetooth

## Using Bluetooth

---

Bluetooth is a short-range wireless communications technology that allows devices to exchange information over a distance of about eight meters without requiring a physical connection.



Turn off Bluetooth when not in use to conserve battery power, or in places where using a wireless device is prohibited, such as on board an aircraft and in hospitals.

Bluetooth® Profiles Supported:

- Headset
- Handsfree
- Stereo
- Phonebook Access Profiles

### Turning Bluetooth on or off

1. Press HOME > MENU, and then tap **Settings** > **Wireless & networks**.
2. Select or clear the **Bluetooth** check box.

An even easier way to turn Bluetooth on or off is with the Bluetooth widget on the Home screen. For instructions on adding a widget to the Home screen, see “Adding a widget to your Home screen” in the Personalizing chapter.

### Changing the phone name

The phone name identifies your phone to other devices.

1. Press HOME > MENU, and then tap **Settings** > **Wireless & networks**.
2. If the **Bluetooth** check box is not selected, select it to turn Bluetooth on.
3. Tap **Bluetooth settings** > **Device name**.
4. Enter the name for your phone in the dialog box, and then tap **OK**.

## Connecting a Bluetooth headset or car kit

---

You can listen to music over an Bluetooth stereo headset, or have hands-free conversations using a compatible Bluetooth headset or car kit. It's the same procedure to set up stereo audio and hands-free.

For you to listen to music with your headset or car kit, the headset or car kit must support the A2DP Bluetooth profile.

1. Press HOME  > MENU, and then tap **Settings > Wireless & networks > Bluetooth settings**.
2. If Bluetooth is not switched on, tap the **Bluetooth** check box to switch it on.
3. Make sure that the headset is discoverable, so that your phone can find the headset. Refer to the instructions that came with the headset to find out how to set it in discoverable mode.
4. Tap **Scan for devices**. Your phone will start to scan for Bluetooth devices within range.
5. When you see the name of your headset displayed in the Bluetooth devices section, tap the name. Your phone then automatically tries to pair with the headset.
6. If automatic pairing fails, enter the passcode supplied with your headset.

The pairing and connection status is displayed below the hands-free headset or car kit name in the Bluetooth devices section. When the Bluetooth headset or car kit is connected to your phone, the Bluetooth connected icon  is displayed in the status bar. Depending on the type of headset or car kit you have connected, you can then start using the headset or car kit to listen to music and/or make and receive phone calls.

### Reconnecting a headset or car kit

When you have paired a headset with your phone, you should be able to reconnect it automatically by turning on Bluetooth on your phone, and then turning on the headset. However, sometimes you will need to reconnect manually, for example if you have been using your headset with another Bluetooth device.

1. Press HOME  > MENU, and then tap **Settings > Wireless & networks > Bluetooth settings**.
2. If Bluetooth is not switched on, tap the **Bluetooth** check box to switch it on.
3. Make sure that the headset is discoverable.
4. Tap the headset's name in the Bluetooth devices section.
5. If prompted to enter a passcode, try 0000 or 1234, or consult the headset/car kit documentation to find the passcode.

If you still cannot reconnect to the headset or car kit, follow the instructions in “Unpairing from a Bluetooth device” in this chapter, and then follow the instructions under “Connecting a Bluetooth headset or car kit” above.

# Disconnecting or unpairing from a Bluetooth device

---

## Disconnecting a Bluetooth device

1. Press HOME  > MENU, and then tap **Settings > Wireless & networks > Bluetooth settings**.
2. In the Bluetooth devices section, press and hold the device to disconnect.
3. Tap **Disconnect**.

## Unpairing from a Bluetooth device

You can make your phone forget its pairing connection with another Bluetooth device. To connect to the other device again, you may need to enter or confirm a passcode again.

1. Press HOME  > MENU, and then tap **Settings > Wireless & networks > Bluetooth settings**.
2. In the Bluetooth devices section, press and hold the device to unpair.
3. Tap **Disconnect & unpair**.







## Sending and receiving information using Bluetooth

---

You can use Bluetooth to transfer information between your phone and another Bluetooth-enabled device such as a phone or notebook computer. The first time you transfer information between your phone and another device, you need to enter or confirm a security passcode. After that, your phone and the other device are paired, and you will not need to exchange passcodes to transfer information in the future.

### Sending information from your phone to another device

You can send the following types of information, depending on the device you are sending to:

- Images and videos
  - Calendar events
  - Contacts
  - Audio files (only unprotected files can be sent)
1. Set the receiving device to discoverable mode. You may also need to set it to “Receive Beams” or “Receive Files”. Refer to the device’s documentation for instructions on receiving information over Bluetooth.
  2. On the phone, open the application that contains the information or file you want to send. For example, if you want to transfer a photo, press HOME , and then tap  > Photos.
  3. Follow the steps for the type of item you want to send:
    - **Photo or video** (in Camera). After capturing a photo, on the preview screen, tap the Share button , and then tap **Bluetooth**.
    - **Photos and videos** (in Photos). On the Albums tab , tap an album. Tap the Share button , tap **Bluetooth**, select the items you want to share, and then tap **Next**.
    - **Calendar event**. In the Calendar’s Day view, Agenda view, or Week view, press and hold the event, and then tap **Share vCalendar > Bluetooth**.
    - **Contact**. On the People screen’s All tab , press and hold the contact, and then tap **Send contact as vCard**. Tap the down arrow icon, and then select **Bluetooth** from the displayed list. Then tap **Send**.
    - **Music track**. With the track displayed on the Now playing screen, press MENU, and then tap **Share > Bluetooth**.
    - **Voice recording**. On the main Voice Recorder screen, tap the Share button , and then tap **Bluetooth**.
  4. If you are prompted to turn on Bluetooth, tap **Turn on**.
  5. Tap **Scan for devices**.
  6. Tap the name of the receiving device.
  7. If prompted, accept the connection on the receiving device, and enter the same passcode on both your phone and the other device, or confirm the auto-generated passcode.
  8. On the receiving device, accept the file.

The location where the information is saved depends on the type of information and the receiving device:

- If you send a calendar event or contact, it is normally added directly to the corresponding application on the receiving device. For example, if you send a calendar event to a compatible phone, the event is shown in that phone's calendar application.
- If you send another file type to a Windows computer, it is normally saved in the Bluetooth Exchange folder within your personal document folders. Refer to your Windows computer operating system's documentation for more information.
- If you send a file to another device, the saved location may depend on the file type. For example, if you send an image file to another mobile phone, it may be saved in a folder named "Images".

## Receiving information from another device

Your device is capable of receiving a wide variety of file types with Bluetooth, including photos, music tracks, and documents such as PDFs.

To receive files from another device, you need to have an SD card installed in your phone.



1. Press HOME  > MENU , and then tap **Settings > Wireless & networks > Bluetooth settings**.
2. If Bluetooth is not switched on, tap the Bluetooth check box to switch it on.
3. Tap the **Discoverable** check box.
4. On the sending device, send one or more files to your phone. Refer to the device's documentation for instructions on sending information over Bluetooth.
5. If prompted, enter the same passcode on both your phone and the other device, or confirm the auto-generated passcode. A Bluetooth authorization request is displayed on your phone.
6. If you want to automatically receive files from the sending device in future, select the **Always** check box.
7. Tap **Accept**.
8. When your phone receives a file transfer request notification, slide down the notifications panel, and then tap **Accept**.
9. When a file is transferred, a notification is displayed. To open the file immediately, slide down the notifications panel, and then tap the relevant notification.

When you open a received file, what happens next depends on the file type:

- Media files and documents are usually opened directly in a compatible application. For example, if you open a music track, it starts playing in the Music application.
- For a vCalendar file, select the calendar where you want to save the event, and then tap **Import**. The vCalendar is added to your Calendar events. For information on using Calendar, see the Calendar chapter.
- For a vCard contact file, if there are multiple vCard files on your storage card, you can choose to import one, several, or all of those contacts to your contacts list.

## Adding the Bluetooth received folder to the Home screen

You can add a folder to the Home screen that shows all files you have received with Bluetooth.

1. Press HOME , and then tap .
2. On the Add to Home screen, tap **Folder > Bluetooth Received**.
3. Press and hold the Bluetooth received folder icon, and drag it to the Home screen position you want.

To view the folder contents, tap the folder icon. To open a file, tap the file name.



# Camera

## Camera basics



---

Whether traveling for business or fun, enjoy taking photos and videos of your trip and encounters with your phone's camera.



Be sure to plug in your microSD card before you use your phone's camera. Photos and videos captured with the camera will be stored onto your microSD card.

If you have not yet inserted your microSD card to your phone, follow the steps in “Inserting the storage card” in the Basics chapter to insert it.

- To open the camera in photo mode and take photos, press HOME  and then tap **Camera**.
- To open the camera directly in video mode so you can immediately start capturing videos, press HOME , tap , and then tap **Camcorder**.

## Viewfinder screen

The camera displays in landscape view only. You'll find the following controls on the Viewfinder screen:



- 
- 1**  **Menu tab**  
Tap to open the menu panel and change camera settings.  
See “Changing camera settings” for details.

---

  - 2**  **View button**  
Tap to open the Photos application so you can browse through and view the photos and videos in your storage card.  
See the Photos chapter for details.

---

  - 3**  **Auto-focus indicator**  
Whenever you point the camera at a different subject or location, the screen shows the auto-focus indicator at the center as the camera automatically focuses on the center of the screen.  
When you tap another area on the screen, the indicator will move to where you tapped and the camera will automatically focus on that area.

---

  - 4**  **Zoom button**  
Tap to display or hide the onscreen zoom bar.  
See “Zooming” for details.
-

---

5  Flash button

Tap to switch between the different camera flash modes.

---

## Using the optical joystick as the shutter release

The optical joystick works as the shutter release for the camera. Press the optical joystick to take a photo or begin capturing video. Press it again to stop capturing video.

## Review screen

After capturing a photo or video, the Review screen will display the photo or the starting image of the video that you have just captured. You can tap the onscreen buttons to delete the photo or video, view it in the Photos application, or share it.



Back

Return to the Viewfinder screen.



Delete

Delete the captured photo or video.



Share

Send the captured photo or video to another phone or your computer using Bluetooth, send it by email, or select a social network where you want to upload it to.



View

Open and use the Photos application to view the captured photo or video, rotate your captured photo, and more. See the Photos chapter for details.

# Zooming

---



Before taking a photo or video, you can first use the onscreen zoom bar to zoom in or out of your subject.

1. To display the onscreen zoom bar, tap the **Zoom** button . You can also slide your finger up or down the Viewfinder screen.

While the zoom bar is shown on the Viewfinder screen, you will also see the remaining photo shots or remaining video recording duration on the upper-right side of the screen.

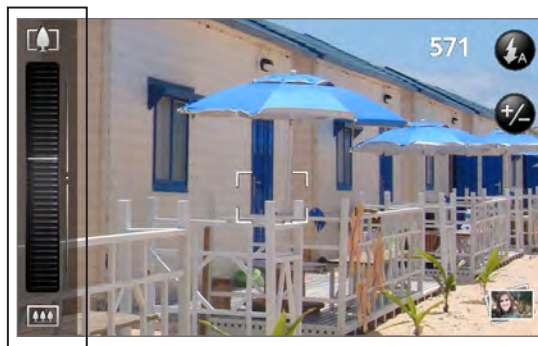



2. You can do the following:
  - To slowly zoom in or out, slide your finger up or down the Viewfinder screen. You can also drag your finger across the zoom bar.



- Tap  to zoom in to the highest magnification.
  - Tap  to zoom out to the actual size.
3. After you're done, wait for a few seconds for the zoom bar to automatically disappear from the screen. You can also tap the **Zoom** button again or tap the Viewfinder screen to hide it.

## Taking a photo

---

1. Press HOME  and then tap **Camera**.
2. Before taking the photo, you can zoom in first on your subject. See “Zooming” to find out how to use the onscreen zoom bar.
3. On the Viewfinder screen, tap the **Flash** button repeatedly to select a camera flash mode depending on your lighting conditions:
  -  Auto flash
  -  Flash on
  -  Flash off
4. Frame your subject on the Viewfinder screen.
5. Let the camera auto focus on the center of the screen, or you can touch another area on the screen that you want to focus on.
6. Press the optical joystick to take the photo.
7. Choose what you want to do with the photo you’ve just taken. See “Review screen” for details.

### Camera flash doesn’t turn on?

Using the flash eats up much battery power. To save battery power, the camera disables the flash (even when you have set the camera flash mode to **Auto flash** or **Flash on**) when one of the following occurs:

#### You have an incoming call

The flash will be disabled temporarily when you have an incoming call. After the call ends, you’ll be able to use the flash again.

If you have set the flash to **Flash on**, it turns back on after you answer and end the call.



#### Your phone’s battery level reaches 15% or lower

Recharge the battery so that the camera can have enough battery power to use the flash.

#### Cold weather may lower battery performance which affects the flash

To make sure the camera has enough battery life to power up the flash, keep your phone warm. When not in use, put the phone inside your jacket to keep it warm, and try to avoid sudden temperature changes that may affect battery performance.

## Capturing a video

1. Press HOME , tap , and then tap Camcorder.
2. Before capturing video, you can zoom in first on your subject. See “Zooming” to find out how to use the onscreen zoom bar.
3. Frame your subject on the screen.
4. Let the camera auto focus on the center of the screen, or you can touch another area on the screen that you want to focus on.
5. Press the optical joystick to start capturing video.



6. To stop capturing, press the optical joystick again.
7. Choose what you want to do with the video you've just captured. See “Review screen“ for details.

## Camera settings

Open the menu panel to change basic camera settings and access more camera settings. You can also switch between photo and video modes from the menu panel.

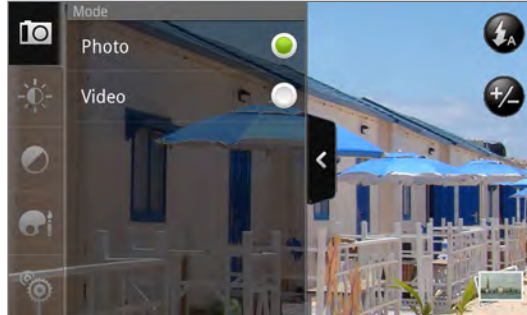

### Changing basic settings

1. On the Viewfinder screen, tap  to open the menu panel.
2. To change basic camera settings, tap one of these icons in the menu panel:



#### Exposure

There's a Brightness bar that allows you to adjust the brightness level. Slide your finger up or down the Brightness bar to increase or decrease brightness.



#### Image properties



Slide your finger across each of the slider bars to adjust the contrast, saturation, and sharpness.



#### Effect

You can apply a special effect to photos and videos that you will capture. Scroll through the Effect menu and choose from effects such as sepia, solarize, posterize, and more.

### Changing advanced settings

1. On the Viewfinder screen, tap  to open the menu panel.
2. Tap  in the menu panel to display the Settings menu and access more camera settings. The following are settings that you can change from the Settings menu:

#### White balance

White balance enables the camera to capture colors more accurately by adjusting to your current lighting environment. White balance settings include: Auto, Incandescent, Fluorescent, Daylight, and Cloudy.

#### ISO (photo mode only)

You can choose an ISO level or set it back to Auto. Higher ISO numbers are better for taking pictures in low light conditions.

#### Resolution

Select a photo or video resolution to use for capturing.

### Widescreen (photo mode only)

When this check box is selected (default), photo resolutions available for selection are in 5:3 ratio and you can use the entire Viewfinder screen to frame your subject. When not selected, photo resolutions available for selection are in standard 4:3 ratio.

### Quality (photo mode only)

Select the quality level to use for capturing photos.

### Self-timer (photo mode only)

If you need to take a self-portrait or group photo, you can set the self-timer to either 2 or 10 seconds.

### Geo-tag photos (photo mode only)

Select this check box when you want to store GPS location in your captured photos.

### Recording length (video mode only)

Set the maximum duration or file size for capturing video.

### Record with audio (video mode only)

Select or clear the check box, depending on whether you want to record audio when capturing videos.

### Metering mode

Set how the camera measures the amount of light to calculate the best exposure:

- **Spot** metering mode allows the camera to measure light around the focus point.
- **Center area** mode allows the camera to measure light in the center.
- **Average** mode allows the camera to measure light in the whole image.

### Review duration

Set the time for a captured photo or video to be displayed on the Review screen before the camera changes back to the Viewfinder screen.

### Flicker adjustment

When taking indoor shots under fluorescent lighting, keep this setting on Auto or change it to the proper frequency (50Hz or 60Hz) of the power in your country to reduce flicker.

### Auto Focus

This option enables or disables centered auto focus. Auto focus is enabled by default.

### Shutter sound

Select or clear this check box, depending on whether you want the camera to play a shutter sound when you press the shutter release.

### Time stamp (photo mode only)

Select this check box when you want the date and time to be added on captured photos.

### Grid (photo mode only)

Select this check box when you want to display a grid on the Viewfinder screen so you can easily frame and center your subject before taking the photo.

### Reset to default

Tap to change the camera back to default settings.

# Photos

## About the Photos application

---

Using the **Photos** application, you can view photos and watch videos that you've taken with your phone's camera, downloaded, or copied onto your storage card. You can also take a look at your photos and your friends' photos that are on your social networks (Facebook and Flickr only).

For photos that are in your storage card, you can do basic editing such as rotate and crop. You can also easily make a photo as your contact picture or wallpaper and share photos with your friends.

## Selecting an album

---

To open the Photos application, press HOME , tap , and then tap **Photos**.

The Photos application opens in the Albums screen where your photos and videos are organized by albums for easy viewing.

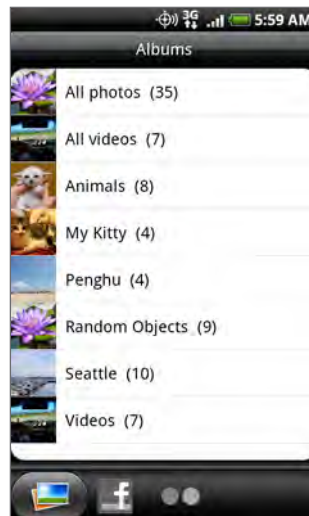

The following are preset albums:

- **Camera shots** lets you view photos and videos that are stored in the camera's folder.
- Photos and videos that you set as your favorites will be grouped under **My favorites**.
- **All photos** lets you view all photos that are stored in all the folders on the storage card.
- **All videos** lets you view all videos that are stored in all the folders on the storage card.
- **All downloads** lets you view photos and videos that you downloaded.

Folders in your storage card that contain photos and videos will also be treated as albums and will be listed below the preset albums. The actual folder names will be used as the album names.

Simply tap an album to view the photos and/or videos in that album.



If there are photos or videos under the root path of your storage card (that are not contained in folders), they will be grouped under the **Other** album.



## Viewing photos and videos

After selecting an album from the Photos application's Albums screen, you can browse through the photos and videos of that album either in filmstrip or grid view. Tap a photo or video to view it in full screen.

### Browsing in filmstrip or grid view

By default, photos and videos are presented in a horizontal filmstrip. Slide your finger left or right across the filmstrip to go through the photos and videos.



From the filmstrip view, press MENU and then tap **Grid view** to browse photos and videos by thumbnails. Slide your finger up or down to scroll through the thumbnails.

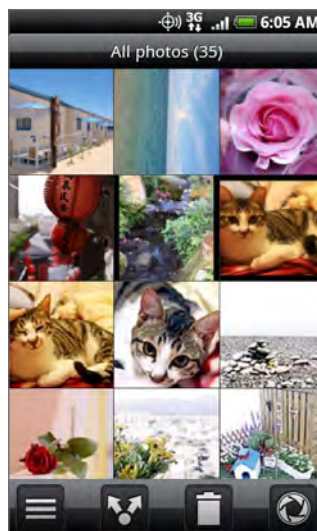

To change back to displaying photos and videos in a filmstrip, press MENU and then tap **Filmstrip view**.



- Whether you're in filmstrip or grid view, you can press and hold on a photo or video to open a selection menu and choose what to do with the photo or video.
- If you want to select another album, tap  to return to the Photos application's Albums screen.

## Viewing a photo in landscape orientation

Turn your phone sideways to the left to view the picture in landscape mode. The picture orientation automatically adjusts to how you hold the phone.

## Zooming in or out on a photo

There are two ways you can zoom in or out of a photo:

- Tap the screen twice quickly to zoom in, then tap the screen twice quickly again to zoom out.
- You can also use pinch zooming. Press your thumb and index finger on the screen and then spread your fingers apart to zoom in. Pinch your fingers together to zoom out.

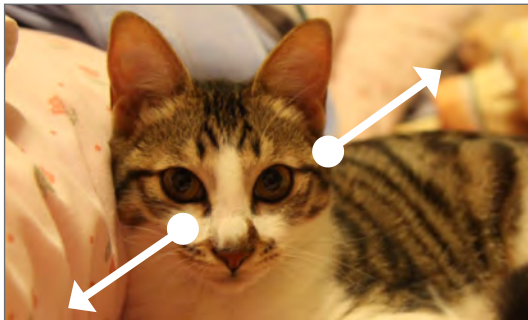

Zooming in

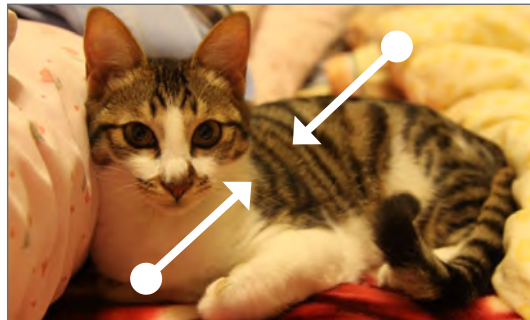

Zooming out

## Watching video

The screen automatically switches to landscape mode when you play a video. Use the onscreen controls to play, pause, or stop the video.



The video is displayed in full screen size. You can tap  to make it best fit on the screen based on the video size. Tap the button again to change back to full screen size.



## Viewing photos in your social networks

---

Using the Photos application, you can view your photos and your friends' photos that are in your social networks (Facebook and Flickr only).

### Viewing photos on Facebook

You need to be logged in to your Facebook account to view Facebook photos.

1. Press HOME , tap , and then tap **Photos**.
2. Tap the **Facebook** tab.
3. Tap your account name or your friend's account on the list to view the pictures in the account.

You can view photos in your online albums the same way as how you view photos in your storage card.

### Viewing photos on Flickr

You need to be logged in to your Flickr account to view Flickr photos.

1. Press HOME , tap , and then tap **Photos**.
2. Tap the **Flickr** tab.

You may be asked to give authorization for the application to connect to the Flickr website. If this happens, you need to give authorization to access your Flickr account.



3. Tap your account name or your friend's account on the list to view the photos in the account.

You can view photos in your online albums the same way as how you view photos in your storage card.

## Working with photos

Whether you're browsing photos in filmstrip or grid view in the Photos application, you can press and hold on a photo to open a selection menu and choose what to do with it. You can choose to delete the photo, rotate or crop it, and more.



### Rotating and saving a photo

1. Press HOME , tap , and then tap **Photos**.
2. From the Photos application's Albums screen, tap an album.
3. Choose whether to browse photos and videos in the album in filmstrip or grid view. See "Browsing in filmstrip or grid view" for details.
4. Press and hold on the photo that you want to rotate.
5. In the menu that opens, tap **Rotate**, and then select either **Rotate left** or **Rotate right**.



You can also rotate a photo while you're viewing it in full screen. Press MENU, tap **Rotate**, and then select either **Rotate left** or **Rotate right**.

### Cropping a photo

1. Press HOME , tap , and then tap **Photos**.
2. From the Photos application's Albums screen, tap an album.
3. Choose whether to browse photos and videos in the album in filmstrip or grid view. See "Browsing in filmstrip or grid view" for details.
4. Press and hold on the photo that you want to crop.
5. In the menu that opens, tap **Crop**. A crop box then appears on the photo.



6. To adjust the crop box size, press and hold the edge of the box. When directional arrows appear, drag your finger inward to or outward to resize the crop box.
7. To move the crop box to the part of the photo that you want to crop, drag the crop box to the desired position.
8. Tap **Save** to apply the changes to the picture.

The cropped picture is saved in the storage card as a copy. The original picture remains unedited.



You can also crop a photo while you're viewing it in full screen. Press MENU, tap More > Crop, and follow the same cropping steps as above.



## Sharing

---

Using the Photos application, you can send photos and videos via email or MMS. You can share photos on your social networks (such as Facebook, Flickr, Picasa, and Twitter) and share videos on YouTube. You can also send them to another phone or your computer using Bluetooth.

### Sending photos or videos by email

You can send several photos, videos, or both in an email message. They are added as file attachments in your email.



1. Press HOME , tap , and then tap **Photos**.
2. Tap the album where the photos or videos you want to share are in.
3. Tap  and then on the **Share** options menu, tap **Gmail/Google Mail** or **Mail**.
4. Select the photos or videos you want to share and then tap **Next**.
5. Compose your message and then tap **Send**.



If you selected **Mail** and you have multiple email accounts, the default email account will be used.



### Sending a photo or video by MMS

Although you can send several photos or videos in a multimedia message, it may be better to just send one at a time, especially if the files are big in size.

1. Press HOME , tap , and then tap **Photos**.
2. Tap the album where the photo or video you want to share is in.
3. Tap  and then on the **Share** options menu, tap **Messages**.
4. Tap the photo or video you want to send.
5. The photo or video is automatically added into the MMS message.
6. Compose your message and then tap **Send**.



### Sending photos or videos using Bluetooth

You can select several photos, videos, or both and send them to someone's phone or your computer using Bluetooth.

1. Press HOME , tap , and then tap **Photos**.
2. Tap the album where the photos or videos you want to share are in.
3. Tap  and then on the **Share** options menu, tap **Bluetooth**.
4. Select the photos or videos you want to share and then tap **Next**.
5. In the next few steps, you'll be asked to turn on Bluetooth on your phone and connect to the receiving Bluetooth device so the files can be sent. Follow the steps in "Sending information from your phone to another device" in the Bluetooth chapter.



## Sharing photos on Facebook

You need to be logged in to your Facebook account to be able to upload pictures.

1. Press HOME , tap , and then tap **Photos**.
2. Tap the album where the photos you want to share are in.
3. Tap  and then on the **Share** options menu, tap **Facebook for HTC Sense**.
4. Select the pictures you want to share and then tap **Next**.
5. Select which album to upload to and set privacy settings for the uploaded pictures. Tap **Done**.





## Sharing photos on Flickr

You need to be logged in to your Flickr account to be able to upload pictures.

1. Press HOME , tap , and then tap **Photos**.
2. Tap the album where the photos you want to share are in.
3. Tap  and then on the **Share** options menu, tap **Flickr**.
4. Select the pictures you want to share and then tap **Next**.
5. Select which album to upload to and set privacy settings for the uploaded pictures. Tap **Done**.



## Sharing photos on Picasa

You need to be signed in to a Google Account to be able to upload pictures to the Picasa™ photo organizing service.

1. Press HOME , tap , and then tap **Photos**.
2. Tap the album where the photos you want to share are in.
3. Tap  and then on the **Share** options menu, tap **Picasa**.
4. Select the pictures you want to share and then tap **Next**.
5. Select the online album where you want to upload the pictures, or tap  to create a new album.
6. Tap **Upload**. You can view the photos online at <http://picasaweb.google.com>.

## Sharing videos on YouTube

You can share your videos by uploading them to YouTube™. Before you do this, you must create a YouTube account and sign in to that account on your phone.

1. Press HOME , tap , and then tap **Photos**.
2. Tap the album where the videos you want to share are in.
3. Tap  and then on the **Share** options menu, tap **YouTube**.
4. Select the videos you want to share and then tap **Next**.
5. Enter the prompted information, such as description and tags, and select a privacy option.
6. Tap **Upload**.

# Music

## About the Music application

Enjoy listening to songs and music on your phone using the **Music** application. You need to copy music files to your storage card first to use the Music application to play music. To find out how to copy files, see “Copying files to and from the storage card” in the Basics chapter.

## Playing music

To open the Music application, press HOME , tap , and then tap **Music**.

The Music application opens in the Playback screen. Use the onscreen controls to control music playback, select a song to play, repeat songs, and more. On the Playback screen, you can also swipe your finger from right to left or left to right to go to the next or previous music album.

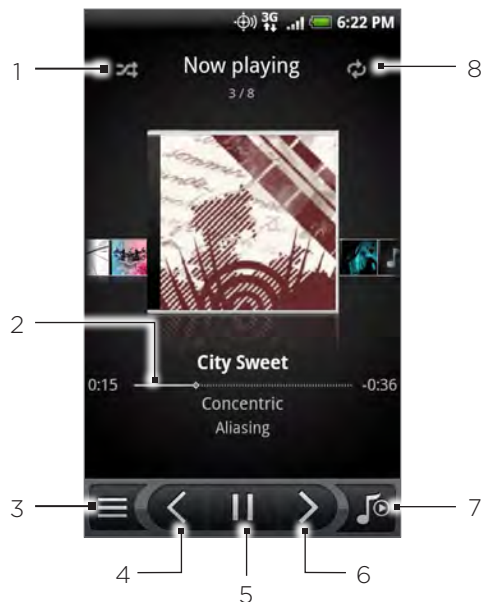

- 1 Tap to turn shuffle on or off. (Shuffle is off when button is gray.)
- 2 Press and drag your finger across the progress bar to jump to any part of the song.
- 3 Tap to go to the Library.
- 4 Tap to go to the previous song in the Now playing list.
- 5 Tap to play, pause, or resume playing the song.
- 6 Tap to go to the next song in the Now playing list.
- 7 Tap to toggle between showing the Now playing list and Playback screen.
- 8 Tap to cycle through the repeat modes: Repeat all songs, Repeat current song, and Don't repeat.

When playing music and the screen turns off, you can control the music playback right from the Lock screen when you “wake up” the phone by pressing POWER. If you do not see the playback controls on the Lock screen, tap anywhere on the screen to display the playback controls.



- Press the VOLUME UP or VOLUME DOWN button to adjust the playback volume.
- If you are using the wired headset to listen to music, press the center button to toggle between playing and pausing playback. Press the previous or next button to go to the previous or next song.

## Browsing music in the Library

---

Tap  at the bottom-left corner of the Music application's Playback screen or Now playing list to go to the Library.



In the Library, your music is organized into different categories such as Albums, Artists, Genres, Composers, and more. Select a category by tapping one of the category tabs at the bottom of the screen.



When you tap a song in a category to play it, the Now playing list is updated with the song list from your selected category.



## Creating a playlist

---

Personalize your music experience by creating music playlists. Make a playlist containing just your favorite songs or create one to match your mood for the day. You can make as many playlists as you like.

1. Press HOME , tap , and then tap **Music**.
2. Tap  at the bottom-left corner of the screen to go to the Library.
3. In the Library, tap or slide your finger on the bottom row to go to the **Playlists** category.
4. Tap **Add playlist**.
5. Enter a playlist name, and then tap **Add songs to playlist**.
6. Tap or slide your finger on the bottom row to change among the different categories. If you go to the **Songs** category, you can see a complete list of songs on your storage card.
7. Select the check boxes of songs you want to add to the playlist and then tap **Add**.
8. Tap **Save**.

### Playing the songs in a playlist

1. In the Library, tap or slide your finger on the bottom row to go to the **Playlists** category.
2. Tap a playlist to open it.
3. Tap the first song or any song in the playlist.

When you tap a song in the list to play it, the Now playing list is updated with the song list from your playlist.

### Managing playlists

After creating a playlist, you can add more songs to it, rearrange their order, and more.

#### Adding more songs to a playlist

1. In the Library, tap or slide your finger on the bottom row to go to the **Playlists** category.
2. Tap a playlist to open it.
3. Press MENU and then tap **Add songs**.
4. Go to the **Songs** category or any other category.
5. Select the songs you want to add to the playlist and then tap **Add**.



While playing back a song, press MENU and then tap **Add to playlist** to add the current song to a playlist.

### Rearranging songs in a playlist

1. In the Library, tap or slide your finger on the bottom row to go to the **Playlists** category.
2. Tap a playlist to open it.
3. Press MENU and then tap **Change order**.
4. Press and hold  at the end of the song title you want to move. When the row is highlighted, drag it to its new position, then release.
5. Tap **Done**.

### Deleting songs from a playlist

1. In the Library, tap or slide your finger on the bottom row to go to the **Playlists** category.
2. Tap a playlist to open it.
3. Press MENU and then tap **Remove songs**.
4. Select the songs you want to delete and then tap **Remove**.



### Deleting playlists

1. In the Library, tap or slide your finger on the bottom row to go to the **Playlists** category.
2. Press MENU and then tap **Delete playlists**.
3. Select the playlists to delete and then tap **Delete**.

## Setting a song as ringtone

---

You can select a song from the Music application's Library and set it as your phone's ringtone or a ringtone for a certain contact.

1. Press HOME , tap , and then tap **Music**.
2. Tap  at the bottom-left corner of the screen to go to the Library.
3. In the Library, select the song that you want to use as ringtone and then play it back.
4. On the Playback screen, press MENU and then tap **Set as ringtone**.
5. In the Set as ringtone options menu, tap **Phone ringtone** or **Contact ringtone**.

If you select **Contact ringtone**, you need to select the contacts you want to associate the song with in the next screen.



### Checking if the song was added as a ringtone

1. On the Home screen, press MENU and then tap **Settings**.
2. On the Settings screen, tap **Sound & display > Phone ringtone**. The song should be in the ringtone list and selected.

## Sending music using Bluetooth

---

You can select a song from the Music application's Library and send it to someone's phone or your computer using Bluetooth (only unprotected files can be sent).

1. Press HOME , tap , and then tap **Music**.
2. Tap  at the bottom-left corner of the screen to go to the Library.
3. In the Library, select the song that you want to use as ringtone and then play it back.
4. On the Playback screen, press MENU and then tap **Share > Bluetooth**.
5. In the next few steps, you'll be asked to turn on Bluetooth on your phone and connect to the receiving Bluetooth device so the music can be sent. Follow the steps in "Sending information from your phone to another device" in the Bluetooth chapter.

## About the Music widget

---

You can use the Music widget to play music right from your Home screen. To find out how you can add this widget to your Home screen, see "Personalizing your Home screen with widgets" in the Personalizing chapter.

# Maps and location

## Using Google Maps

---

Google Maps lets you track your current location, view real-time traffic situations, and receive detailed directions to your destination. It also provides a search tool where you can locate places of interest or an address on a vector or aerial map, or view locations in street level.



- You need an active mobile data or Wi-Fi connection to use Google Maps.
- The Google Maps application does not cover every country or city.

## Viewing locations

### Turning on location services



Before you open Google Maps and find your location or search for places of interest, you must enable location sources.

1. Press HOME  > MENU and then tap Settings > Location.
2. Select Use wireless networks, Use GPS satellites, or both.



Selecting Use GPS satellites lets you locate places of interest at street level. However, this requires a clear view of the sky and more battery power.

### Finding your location

1. Press HOME , and then tap  > Maps.
2. On the Google Maps screen, press MENU and then tap My Location. Your location is shown on the map as a blinking blue dot.

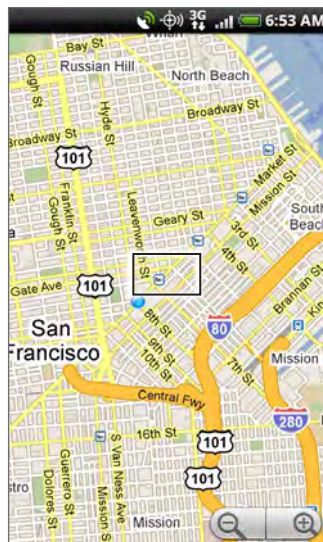

### Moving on the map

Swipe your finger on the screen or the optical joystick to view other areas of the map.

### Zooming in or out of a map

Tap  to zoom in; tap  to zoom out.

## Getting an address and additional information for a location

Touch & hold a location on the map. A balloon opens over the location, with the address and a thumbnail from street view (if available). Tap the balloon to see more information or to get directions to that location.

## Looking at a location in Street View

Street View mode (available only in selected areas) provides a street-level view of the location.

1. Do one of the following:
  - Touch and hold a location on the map, and then tap the balloon that appears.
  - Search for the place you want to view. See “Searching for a location” in this chapter for details. When you find the place, tap its balloon.
2. On the location details screen, tap **Street view**.
3. To navigate in Street View, do any of the following:
  - Swipe your finger on the screen or the optical joystick to pan up or down or to look in other directions.
  - Tap the displayed arrows to move up and down the street.
  - Press MENU to select from other navigation options.



While viewing a Street View of a location, press MENU and then tap **Compass mode** to turn Compass mode on. Tilt, pan, or turn your phone to view the area around the selected location.

## Clearing the map

After you get directions or search on a map (as described in the other parts of this section), you can clear away the various markers such activities draw on the map.

When viewing a map, press MENU and then touch **More > Clear map**.

## Viewing map layers

Initially, Google Maps opens with a street map. You can view additional map layers, such as satellite images, traffic information, your Google Latitude friends' locations, and Wikipedia information on locations. You can also view maps that you and other people have created in Google Maps on the web.



- Multiple layers can be viewed at the same time.
- Not all locations have information to support all Map layers or all zoom levels. To learn more about layers, visit Google Maps on the web: <http://maps.google.com/>

1. While viewing a map, press MENU, and then tap **Layers**.

2. Select any of the following.

- **Traffic** (available only in selected areas). Real-time traffic conditions are displayed over roads as color-coded lines. Each color represents how fast the traffic is moving.

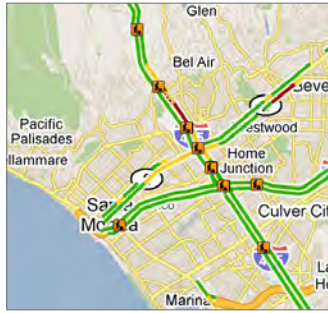

- **Satellite**. Google Maps uses the same satellite data as Google Earth™. Satellite images are not real-time. Google Earth acquires the best imagery available, most of which is approximately one to three years old.

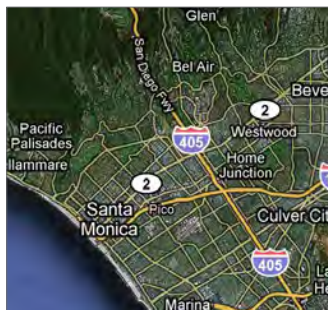

- **Latitude**. When you have joined Latitude, you can view your friends' locations as a layer on the map. For information, see "Finding your friends with Google Latitude (available by country)" in this chapter.
- To select more layers such as transit lines or maps that you have created in Google Maps on the web, tap **More layers**.
- To clear layers and view only the street map, tap **Clear map**.

## Searching for a location

1. While viewing a map, press SEARCH .
2. Enter the place you want to search in the search box. You can enter an address, a city, or type of business or establishment (for example, museums in london).

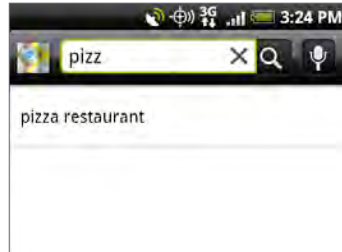

- As you enter information, a list of all the places which you have searched or visited before appears on the screen. You can also tap an address on the menu to show its location on the map.
- You can also tap  and (when prompted) speak the name of the location you are searching for. Search results are instantly displayed.

3. Tap . The search results are displayed on the map.



- 
- 1 Tap to show the search results as a list.
  - 2 Tap to go to the previous or next search item on the map if there are multiple search results.
- 

4. Tap the balloon to show the **Address**, **Details** (if available), and **Reviews** (if available) for each search item.

## Getting directions

Use Google Maps to get detailed directions to your destination.

1. While viewing a map, press MENU and then tap **Directions**.
2. Enter the starting point in the first text box, then enter your destination in the second text box. By default, your current location is entered in the **Starting point** box.

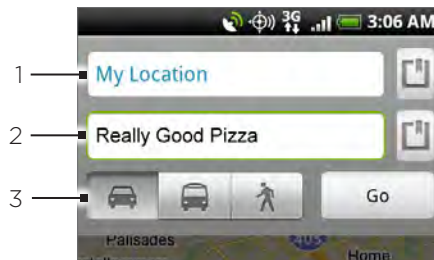

- 1 Select starting point.
- 2 Select destination.
- 3 Choose how you want to get to your destination.

You can also tap  to open the location source menu and select a starting point and destination address.

3. Tap the icon for car, public transit, or walking directions.
4. Tap **Go**. The directions to your destination appear in a list. Tap a direction instruction on the list to show the map.

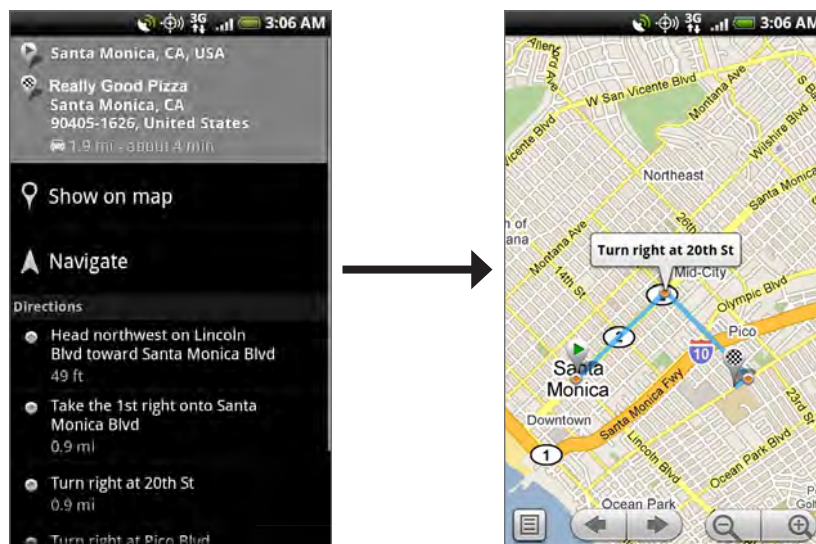

When you are finished viewing or following the directions, press MENU and then tap **More > Clear map** to reset the map. Your destination is automatically saved in the Google Maps history.



## Finding your friends with Google Latitude (available by country)

Google Latitude™ user location service lets you and your friends share locations and status messages with each other. It also lets you send instant messages and emails, make phone calls, and get directions to your friends' locations.

Your location is not shared automatically. You must join Latitude, and then invite your friends to view your location or accept their invitations.

### Joining Latitude

1. While viewing a map, press MENU and then tap **Join Latitude**.
2. Read the privacy policy. If you agree with it, tap **Agree & share**.

After you join Latitude, you can start sharing your locations with your friends. Only friends that you have explicitly invited or accepted can see your location.

### Opening Latitude

After you join Latitude, you can open it to find your friends and view their updates.

While viewing a map, press MENU, and then tap **Latitude**.

### Inviting friends to share their locations

1. While viewing a map, press MENU, and then tap **Latitude**.
2. In Latitude, press MENU, and then tap **Add friends**.
3. Choose how to add friends:
  - **Select from Contacts**. Select any number of friends from your Contacts.
  - **Add via email address**. Enter an email address.
4. Tap **Add friends**.
5. If prompted, tap **Yes**.

If your friends already use Latitude, they receive an email request and a notification on Latitude. If they have not yet joined Latitude, they receive an email request that tells them to sign in to Latitude with their Google Account.

### Responding to an invitation

When you get a sharing request from a friend, you can:

- **Accept and share back**. You and your friend can see each other's locations.
- **Accept, but hide my location**. You can see your friend's location, but they can't see yours.
- **Don't accept**. No location information is shared between you and your friend.

## Viewing your friends' locations

You can view your friends' locations on a map or in a list.

When you open Maps, your friends' locations are shown. Each friend is represented by their picture (from Contacts) with an arrow pointing to their approximate location. If a friend has chosen to share city-level locations, their picture does not have an arrow and appears in the middle of the city.

To see a friend's profile and connect, touch the photo. Your friend's name appears in a balloon. Touch the balloon to open a screen with details about your friend and many connection options.

When you open Latitude you see a list of your Latitude friends, with a summary of their last known locations, status, and so on. Touch a friend in the list to open a screen with details about the friend and many connection options.

## Connecting with and managing friends

Tap a friend's contact details balloon in map view or tap a friend in list view to open the friend's profile. In the profile screen, you can communicate with your friend and set privacy options.

### Show on map

Shows the friend's location on the map.

### Chat using Google Talk

Opens a Google Talk chat window with that friend.

### Send email

Opens Gmail/Google Mail with a message addressed to the friend.

### Get directions

Gets directions to the friend's location.

### Sharing options

Select from the following:

- **Best available location.** Share your precise location information.
- **Share only city level location.** Share only the city you are in, not the street-level location. Your friend can see your photo icon in the middle of the city you are in. To share more precise location again, tap **Best available location**.
- **Hide from this friend.** Stop sharing your location with this friend, in a list or on a map.

### Remove this friend

Remove the friend from your list and stop sharing locations with him or her altogether.

## Changing privacy settings

You have control over how and when you can be found by your friends. Only the last location sent to Latitude is stored with your Google Account. If you turn off Latitude or are hiding, no location is stored.

1. In Google Maps, press MENU, and then tap **Latitude**.
2. Tap your own name, and then tap **Edit privacy settings**.
3. Set the following options to your preferences:

### **Detect your location**

Let Latitude detect and update your location as you move. The update frequency is determined by several factors, such as how recently your location has changed.

### **Set your location**

Choose from several options to manually select your location.

### **Hide your location**

Hide your location from all your friends.

### **Turn off Latitude**



Disable Latitude and stop sharing your location or status. You can always join Latitude again.

## Using HTC Footprints

HTC Footprints™ provides an easy way to record favorite places and revisit those places. A footprint consists of a photo you take of a location such as a restaurant, a sightseeing destination, etc., stored together with a precise GPS position and other information about that location such as the street address and phone number.

The next time you want to visit the same place, simply access the footprint. You can then dial the phone number or view the location in Google Maps.

### Creating a footprint

1. Press HOME , and then tap  > Footprints.
2. Tap **New Footprint**. If GPS is not on, you are prompted to turn it on so that your phone can use GPS to find your location.
3. Point the camera at the scene you want to show the location. Footprints starts to use GPS to search for your position.





To change brightness and white balance settings before you take a photo, press MENU, tap **Brightness** or **White balance**, and then choose a setting.

4. Press the optical joystick to capture the photo. If your GPS position has not been found yet, you are asked whether to find the position on Google Maps, continue the GPS search, or stop the GPS search. You may also be asked if you want HTC Footprints to automatically determine the address for the location.
5. Tap **Done**.



Before pressing **Done**, you can press MENU, and then tap **Edit** to change the name, category, or address of the footprint, enter the phone and website, and add a voice memo to the footprint.

### Revisiting a footprint

1. Press HOME , and then tap  > Footprints.
2. At the bottom of the screen, slide your finger to select the footprint category.





3. Tap the footprint you want to revisit.

4. Scroll down to see more information. You can tap the information fields to view more information about the footprint, call a stored phone number, and more.



- 
- 1 Search for the address in Google Maps.
  - 2 Open the web page.
  - 3 Show the GPS location in Google Maps.
- 

## Editing or deleting a footprint

1. Press HOME , and then tap  > Footprints.
2. On a category screen, press and hold the footprint you want to edit or delete, and then tap **Edit** or **Delete** on the options menu.

## Exporting your footprints

You can back up footprints by exporting them to a storage card. You can also open exported footprint files in other applications such as Google Earth on your PC. To transfer files from your storage card to your computer, see “Copying files to and from the storage card” in the Basics chapter.



Press HOME , tap  > **Footprints**, and then do any of the following:

- To export all your footprints, on the All footprints tab , press MENU and then tap **Export**.
- To export all the footprints from a particular category, while viewing that category, press MENU and then tap **Export**.
- To export a single footprint, open the footprint, press MENU and then tap **Export**.

Exported footprints are saved as .kmz files in the Footprints\_Data folder on your storage card. If you exported multiple footprints at one time, they are saved together in one .kmz file.

## Importing footprints

You can restore footprints you previously backed up to the storage card. You can also import .kmz files that you saved in other applications, or use a photo as a footprint.

1. Press HOME , and then tap  > **Footprints**.
2. Press MENU, and then tap **Import**.
3. Do one of the following:
  - To import saved footprints or another .kmz file from the storage card, tap **Footprints data**, and then tap the file you want to import. If a footprint on the device is the same as one you want to import, you are asked whether you want to overwrite it.
  - To import a photo, tap **Picture**, navigate to the photo you want to import, and then tap the photo. You can then add Footprints information such as location and category.

## Adding the Footprints widget



Add the Footprints widget to view and access your footprints on the Home screen. To learn how to add widgets, refer to “Adding a widget to your Home screen” in the Personalizing chapter.

# More apps

## Watching videos on YouTube

---



**YouTube** is an online video streaming service that allows you to view videos that have been uploaded by YouTube members.

Press HOME , and then tap  > YouTube. YouTube presents the videos grouped into categories, such as Most viewed, Most discussed, Most recent, and Top rated.







- You do not need a YouTube account to browse and view videos. However, to use all the features of YouTube (such as sharing a video), you must create a YouTube account from your computer and sign in to that account from your phone.
- You must have an active Wi-Fi or data connection to access YouTube.

### Watching videos

1. Press HOME , and then tap  > YouTube.
2. On the YouTube screen, scroll through the list of videos, and then tap a video to watch it. The screen automatically switches to landscape view when you play a video.
3. While watching a video, you can:
  - Tap the screen to display the playback controls. When the playback controls are displayed, you can pause, skip forward or backward, or drag the slider to the point in the video you want to watch.
  - Press MENU to rank, comment on, share, flag as inappropriate, and interact with the video in other ways.
4. Press BACK  to stop playback, and return to the videos list.

### Searching for videos



1. Press HOME , and then tap  > YouTube.
2. On the YouTube screen, press SEARCH .
3. Enter a search keyword, and then tap .



Tap  to enter a search keyword by speaking into the microphone.



4. The number of search results appears below the status bar. Scroll through the results and tap a video to watch it.

### Clearing the search history

1. Press HOME , and then tap  > YouTube.
2. Press MENU and then tap **Settings**.
3. Tap **Clear search history**, and then tap **OK** when prompted.



## Sharing a video link

You can share a video by sending its link to your contacts.

1. Press HOME , and then tap  > YouTube.
2. On the YouTube screen, tap a video to watch from the available categories.
3. While watching a video, press MENU, and then tap **Share**.
4. Select how you want to share the video link.

## Capturing a video and sharing it on YouTube

You need to be signed in to your Google Account to upload your video to YouTube.



1. Press HOME , and then tap  > YouTube.
2. Tap .
3. Press the optical joystick to start capturing video. When you are done capturing, press the optical joystick again. Tap **Done**.
4. Enter a title, description, and tags for your video.
5. Set the privacy level.
6. Tap **Upload**.



## Viewing a PDF

---

Use **PDF Viewer** to view PDF files that you have copied to the phone's storage card.

1. Press HOME , and then tap  > **PDF Viewer**.
2. On the Open file screen, tap the file you want to view.
3. Slide your finger on the screen to pan or go through the pages of the PDF. While viewing a PDF, press MENU, and then tap:
  - **Open** to open another PDF file.
  - **Toolbar/Toolbar off** to toggle between showing and hiding the toolbar.
  - **View** to view the PDF in normal view or reformatted view. Choosing **Reformatted** reflows the text and resizes the images to fit the width of the screen, depending on the zoom level.
  - **Zoom** to change the zoom level to either **Fit to screen** or **Fit to width**. This is not available when **Reformatted** is selected for **View**.
  - **Go to** go to a specific page on the PDF.
  - **More** to search the PDF and view file properties or information about the PDF Viewer.



Turn your phone sideways (turn to the left) to view the PDF file in landscape mode. The screen orientation automatically adjusts depending on how you hold the phone.

# Viewing documents, presentations, and spreadsheets

Quickoffice lets you view Microsoft Office Word, Microsoft Office Excel, and Microsoft PowerPoint files on your phone. Quickoffice supports viewing of Microsoft Office 2003 and 2007 Word (.doc), Excel (.xls), PowerPoint (.ppt) and text (.txt) files.



Make sure you have copied the files to the phone's storage card before you open Quickoffice. See "Copying files to and from the storage card" in the Basics chapter to learn how to copy files to the storage card.

1. Press HOME , and then tap  > Quickoffice.
2. On the Open file screen, tap the file you want to open.



In the Open file screen, press MENU and then tap Sort to let you sort the list by Name or Date.

3. Slide your finger on the screen to pan or go through the pages of the file.

**YOUR WARRANTY IS INVALIDATED IF YOU OPEN OR TAMPER WITH THE DEVICE'S OUTER CASING.**

**PRIVACY RESTRICTIONS**  
Some countries require full disclosure of recorded telephone conversations, and stipulate that the consumer must inform the person with whom you are speaking that the conversation is being recorded. Always obey the relevant laws and regulations when using the recording feature of your Pocket PC Phone.

**COPYRIGHT INFORMATION**  
Microsoft, Windows, Windows NT, Windows Server, Windows Mobile, Internet Explorer, MSN, Outlook, PowerPoint, and Word are trademarks or registered trademarks of Microsoft Corporation in the United States and other countries.

**Important Health and Safety Precautions**

When using this product, the safety precautions below must be taken to avoid possible legal liability. Retain and follow all warnings and instructions on the product. To reduce the risk of injury, electric shock, fire, or damage to the equipment:

**ELECTRICAL SAFETY**  
This product is intended for use when supplied with power from the designated battery or power supply unit. Other usage may be dangerous and will invalidate any approval given to this product.

**SAFETY PRECAUTIONS FOR PROPER GROUNDING INSTALLATION**  
**CAUTION** - Connecting to an improperly grounded equipment can result in an electric shock to your device.

**SAFETY PRECAUTIONS FOR POWER SUPPLY UNIT**  
This product equipped with a USB Cable for connecting with desk-top or notebook computer. Be sure your computer is properly grounded (earthed) before connecting this product to the computer. The power supply cord of a desktop or notebook computer has an equipment-grounding conductor and a grounding plug. The plug must be plugged into an appropriate outlet which is properly installed and grounded in accordance with all local codes and ordinances.

fx	
3	Inside the Box (Reference or Copy)
4	Your Phone (Topic Head)
5	Front Panel (Add Phone Controls)
6	Setting Around Your Phone
7	Back Panel
8	Left Panel
9	Bottom Panel
10	Top Panel
11	Installing the SIM Card, Battery Change to "Before Turning On Y
12	Removing the back cover

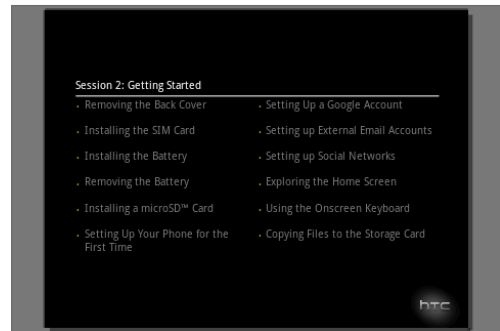

4. While viewing a file, you can:

- Pinch the screen to zoom in or out or use the zoom controls on the screen to zoom in or out.
- For Excel files, press MENU, and then tap **Worksheet** to view other worksheets on the file.
- For Word and PowerPoint files, tap a URL link to open the web page in the web browser.
- When you open Word documents, Quickoffice reformats the text to make it fit the width of the screen. Double-tap the screen to switch to normal view so you can view the page layout.



Quickoffice does not reflow text in tables.

- When you view PowerPoint files, after you zoom in on a slide, you can double-tap the screen to zoom out automatically and fit the slide to the width of the screen.

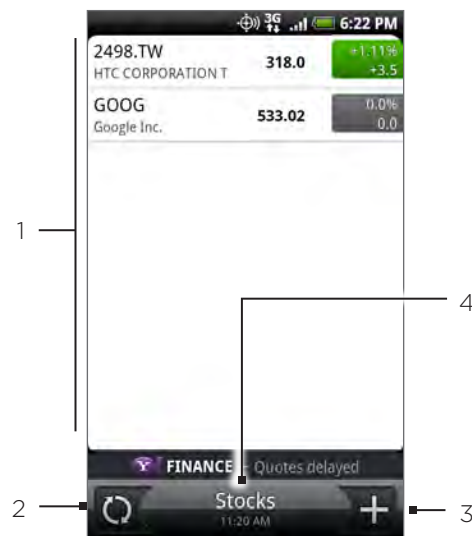

## Keeping track of your stocks

Use Stocks to get the latest stock updates for stock quotes and market indices you follow.



- 
- 1 List of your stock quotes and stock market indices. Tap an item to view its intraday chart and other details.
- 
- 2 Tap to update the stock information.
- 
- 3 Tap to add a stock quote or stock market index.
- 
- 4 Shows the time the information was last updated.
- 

### Adding a stock quote or stock market index



1. Press HOME , and then tap  > Stocks.
2. On the Stocks screen, tap  at the bottom-right corner of the screen.





If there are no stock quotes or indices onscreen, tap **Tap here to add a stock or index** at the top of the screen.

3. Enter the stock quote or stock market index on the text field, and then tap .
4. On the results list, tap the stock quote or stock market index you want to add.



### Changing the stock list order

1. Press HOME , and then tap  > Stocks.
2. Press MENU, and then tap **Rearrange**.
3. Press and hold  at the end of the item you want to move. When the row is highlighted in green, drag it to its new position, and then release.
4. Tap **Done**.

### Deleting stock quotes and indices

1. Press HOME , and then tap  > Stocks.
2. Press MENU, and then tap **Delete**.
3. Select the items you want to delete and then tap **Delete**.

## Setting stock information update frequency



1. Press HOME , and then tap  > Stocks.
2. Press MENU, and then tap **Settings**.
3. Select the **Auto-sync data** check box.





Downloading stock information automatically may incur additional fees from Verizon Wireless.

4. Tap **Set download frequency**, and then select frequency to check for updates.

## Manually updating stock information

1. Press HOME , and then tap  > Stocks.
2. Press MENU, and then tap **Update**.

## Adding the Stocks widget

1. Press HOME , and then tap  > Widget > Stocks.
2. Choose the widget style, and then tap **Select**.
3. Drag the widget to a blank space on the Home screen, and then release.

## Listening to the radio

FM Radio lets you listen to FM radio stations on your phone.





You need to connect a headset first to the audio jack of your phone to use FM Radio. FM Radio uses the stereo headset as the FM radio antenna,



- |    |   |
|----|---|
| 1  | FM radio frequency  |
| 2  | Drag to tune in to a frequency on the FM band.                    |
| 3  | Tap to fine tune the radio frequency by -0.1 MHz.                 |
| 4  | View the All presets list.  |
| 5  | Tap to search the FM band for the previous FM station.            |
| 6  | Tap to search the FM band for the next FM station.                |
| 7  | Tap to change the name of the current station you are tuned into. |
| 8  | Tap to fine tune the radio frequency by +0.1 MHz.                 |
| 9  | Radio signal strength   |
| 10 | Turn FM radio on or off.  |



### Listening to an FM station

1. Press HOME , and then tap  > FM Radio.
2. The first time you open FM Radio, it automatically scans for available FM stations, saves them as presets, and plays the first FM station found.





- To repeat scanning and saving of FM stations, press MENU, and then tap **Scan & Save**.
- Press BACK  to stop the auto-scan.

3. On the FM Radio screen, you can:



- Tap  and then select a station you want to listen to.
- Tap  to go to the previous available FM station, or  to go to the next available FM station.
- Press the VOLUME UP and VOLUME DOWN buttons on the side of the phone to adjust the volume.
- Press MENU to set more FM Radio options.

## Adding station names

1. Press HOME , and then tap  > FM Radio.
2. Tune in to the desired FM station, and then tap .
3. Enter a station name for the selected FM station, and then tap **Save**.

## Minimizing or turning off FM Radio

Do one of the following:

- Press BACK  to minimize and keep FM Radio running in the background so you can listen to the radio while going to another screen.
- On the FM Radio screen, tap  on the upper-right corner of the FM Radio screen to turn FM Radio off.







## Recording your voice

Voice Recorder is useful for quickly recording thoughts. You can also record your voice and set it as a ringtone.





You need to have a microSD card installed on your phone to use Voice Recorder.

### Recording your voice



1. Press HOME , and then tap  > Voice Recorder.
2. Hold the device's microphone near your mouth.
3. Tap  to start recording a voice clip. Tap  to stop recording.
4. Tap  to play back the voice recording.
5. To quickly share the voice recording through Bluetooth, email, or message, tap .

### Sharing a voice clip



1. Press HOME , and then tap  > Voice Recorder.
2. On the Voice Recorder screen, tap .
3. On the All recording screen, press and hold the voice recording you want to share, and then tap **Share** on the options menu.
4. On the Share options menu, select how you want to share the voice recording.

To learn how to send files through Bluetooth, see the Bluetooth chapter.

### Setting a voice clip as a ringtone

1. Press HOME , and then tap  > Voice Recorder.
2. On the Voice Recorder screen, tap .
3. On the All recording screen, press and hold the voice recording you want to set as a ringtone, and then tap **Set as ringtone** on the options menu.

### Renaming a voice clip

1. Press HOME , and then tap  > Voice Recorder.
2. On the Voice Recorder screen, tap .
3. On the All recording screen, press and hold the voice recording you want to rename, and then tap **Rename** on the options menu.
4. Enter the name, and then tap **Save**.

## Using Voice Search

Google Voice Search enables you to do a search with Google by speaking your search query into the microphone.

### Opening Voice Search

1. Press HOME , and then tap  > Voice Search.

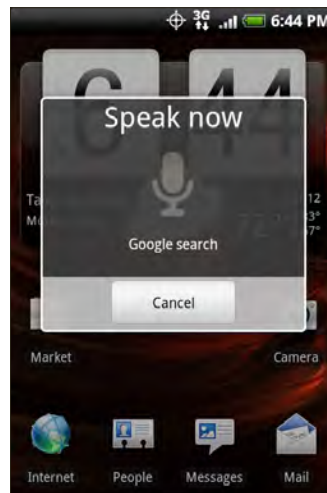

2. Hold the device's microphone near your mouth and speak your search query clearly into the microphone (for example "New York City").

The web browser opens and displays search results.

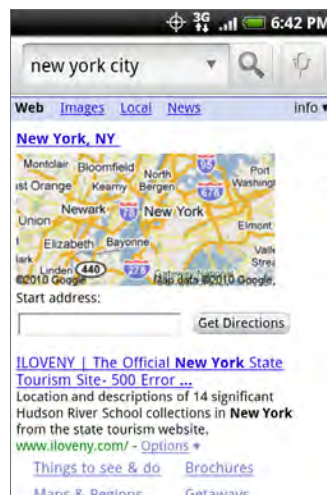



# Navigator

---

Navigator gives you quick and convenient access to the phone, voice search, and navigation apps such as Footprints and Google Maps when the phone is mounted on the car kit. (The car kit with in-car holder for your phone is purchased separately.)

## Opening Navigator

Press HOME , and then tap  > Navigator.



## Finding and installing apps from Android Market

Android Market™ is the place to go to find new apps for your phone. Choose from a wide variety of free and paid apps ranging from productivity apps, entertainment, to games. When you find an app you want, you can easily download and install it on your phone with just a few taps of your finger.

To access Android Market, you must first connect to the Internet using your phone's Wi-Fi or data connection and sign in to your Google Account.

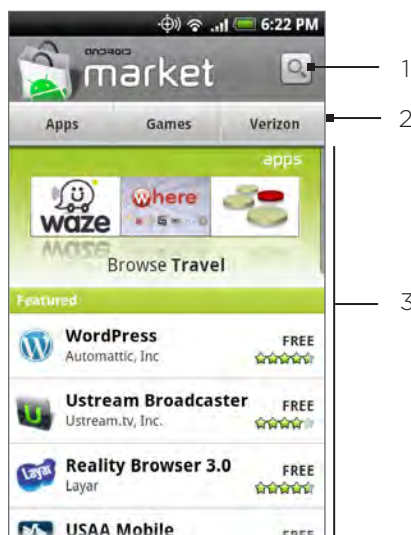



- 
- 1 Tap to search Android Market for apps to install on your phone.
  - 2 Tap to display the available apps or games on Android Market or Verizon.
  - 3 Featured apps list. Tap an app to read a description about the app and user reviews.
- 



Paid apps are currently only available in certain countries.



### Finding and installing an application

When you install apps from Android Market and use them on your phone, they may require access to your personal information (such as your location, contact data, and more) or access to certain functions or settings of your phone. Download and install only apps that you trust.

1. Press HOME , and then tap **Market** or tap  > **Market**.
2. When you open Android Market for the first time, the Terms of Service window will appear. Tap **Accept** to continue.
3. To find an app in Android Market, you can:
  - Browse through featured apps. Scroll through the list of featured apps when you open Android Market.
  - Browse apps by categories. First, tap **Apps** or **Games** and then tap a category. Under a category, you can filter the apps by **Top paid**, **Top free** or **Just in**.



Paid apps are currently only available in certain countries.

- Search for an app. Tap  on the Android Market home screen, enter the name or type of app you're looking for, and then tap  to the right of the search box.
- 4. Tap an app to read a description about the app and user reviews.
- 5. Tap **Install** (for free applications) or **Buy** (for paid applications).



You need a Google Checkout account to purchase items on Android Market. See “Creating a Google Checkout account” to set up a Google Checkout account if you do not have one.

6. The subsequent screen notifies you whether the app will require access to your personal information or access to certain functions or settings of your phone. If you agree to the conditions, tap **OK** to begin downloading and installing the app.

If you selected a paid application, after tapping **OK**, you're redirected to the Google Checkout screen to pay for the application before it's downloaded to your phone



**Read it carefully!** Be especially cautious with applications that have access to many functions or a significant amount of your data. Once you tap **OK** on this screen, you are responsible for the results of using this item on your phone.

After installing an app, tap  on the upper-left side of the screen to return to Android Market home. You can also press **MENU**, and then tap **Home**.

## Creating a Google Checkout account

You must have a Google Checkout account associated with your Google Account to purchase items from Android Market.

Do one of the following:

- On your computer, go to <http://checkout.google.com> to create a Google Checkout account.
- The first time you use your phone to buy an item from Android Market, you're prompted to enter your billing information to set up a Google Checkout account.





When you've used Google Checkout once to purchase an application from Android Market, the phone remembers your password, so you don't need to enter it the next time. For this reason, you should secure your phone to prevent others from using it without your permission. See the Security chapter to learn how to secure your phone.

## Requesting a refund for an application







If you are not satisfied with an application, you can ask for a refund within 24 hours of the purchase. Your credit card is not charged and the application is uninstalled from your phone.

If you change your mind, you can install the application again, but you can't request a refund a second time.

1. Press **HOME** , and then tap  > **Market** > **Menu** > **Downloads**.
2. Tap the application to uninstall for a refund. The details screen for the application opens.
3. Tap **Uninstall & refund**. Your application is uninstalled and the charge is cancelled.
4. Choose the reason for removing the application, and then tap **OK**.



## Opening an installed application

Do one of the following:

- On the status bar, check if you see the  icon. If you see the  icon, open the Notifications Panel, and then tap the app to open it. See “Opening the Notifications panel” in the Basics chapter to learn how to open the Notifications Panel.
- Press HOME , and then tap  > **Market** > **Downloads**. On the Download screen, tap the app to open it.
- Press HOME , and then tap . On the All programs screen, locate the app, and then tap it.

## Uninstalling an application

You can uninstall any application that you have downloaded and installed from Android Market.

1. Press HOME , and then tap  > **Market** > **Downloads**.
2. On the Downloads screen, tap the application you want to uninstall, and then tap **Uninstall**.
3. When prompted, tap **OK** to remove the application on your phone.
4. Choose the reason for removing the application, and then tap **OK**.

## Getting help

If you ever need help or have questions about Android Market, press MENU, and then tap **Help**. The web browser will take you to the Android Market Help web page.

# Security

## Protecting your phone with a screen lock

---

You can secure your phone by requiring a screen unlock pattern every time your phone is turned on or every time it wakes up from sleep mode (screen is off).

1. Press HOME  > MENU, and then tap **Settings**.
2. Scroll down the screen, and then tap **Security** > **Set unlock pattern**.
3. Read the information on the screen, and then tap **Next**.
4. Study the example pattern on the screen, and then tap **Next**.
5. Draw the screen unlock pattern by connecting at least four dots in a vertical, horizontal and/or diagonal direction. Lift your finger from the screen when finished.



You must slide your finger on the screen to create the pattern and not tap individual dots.

6. The phone records the pattern. Tap **Continue**.
7. When prompted, draw the screen unlock pattern again, and then tap **Confirm**.



Clear the **Use visible pattern** check box if you do not want the unlock pattern to display on the screen when you unlock it.

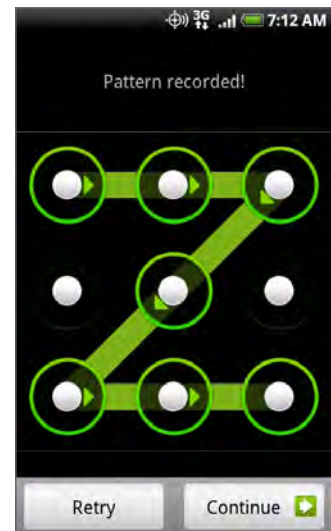

To change your unlock screen pattern, press HOME  > MENU, and then tap **Settings** > **Security** > **Change unlock pattern**.

When you fail to draw the correct unlock pattern on the screen after five attempts, you will be prompted to wait for 30 seconds before you can try again. If you forgot your screen unlock pattern, tap **Forgot pattern**. You will be prompted to sign in using your Google Account name and password, and create a new screen unlock pattern before the Home screen displays.



You need to be connected to a data or Wi-Fi connection to be able to sign in to your Google Account.

# Settings

## Settings on your phone

---

Control and customize phone settings on the Settings screen.

To open the Settings screen, press HOME  > MENU, and then tap **Settings**.

### Personalize

Select a scene, set the Home screen or Lockscreen wallpaper to use, and set the default ringtone to use for incoming calls. You can also rename or delete a custom scene by pressing and holding a custom scene in Scenes.

### Wireless & networks

Configure your phone's wireless connections, such as Wi-Fi and Bluetooth, enable the Airplane mode, or set the options for mobile networks, roaming, Virtual Private Networks, and more.

### Call

Set up call services such as voicemail, auto retry, TTY mode, and assisted dialing.

### Sound & display

Set the phone and notification ringtones, automatic screen orientation, and set the screen brightness and screen timeout.

### Accounts & sync

Log in or out from your social network accounts, Google Account, and Exchange ActiveSync account. You can also manage synchronization and other settings for your accounts. See the Accounts and sync chapter for details.

### Location

Select the sources to use when determining your location.

### Search

Select items to include when you do a search on your phone and set Google search options.

### Privacy

Select whether to allow or block Google from using your location when suggesting results and for other Google services. You can also reset the phone. See the Backup, Update and Reset chapter for more details.

### Connect to PC

Set the default USB connection type when you connect your phone to your computer. Select **Ask me** to always display the connection type dialog box when the device is connected. See "Connecting your phone to a computer" in the Basics chapter for details.

### Security

Set the screen unlock pattern or manage the phone's credential storage. See the Security chapter for details on setting the screen unlock pattern.

## Applications

Manage applications and installation of new programs.

## SD card & phone storage

Check the available storage card and phone memory.

## Date & time

Set the date and time, time zone, and date or time format. To turn off auto time synchronization and be able to manually change time zone settings, see “Changing time zone settings” in the Clock and Weather chapter.

## Language & keyboard

Set the operating system language and region. You can also set onscreen keyboard options.

## Accessibility

Enable or disable preset or downloaded accessibility plugins that respond to user interaction such as receiving sound feedback when a new browser window is opened.

## Text-to-speech

If you have installed a text-to-speech (voice data) application, use this option to configure the text-to-speech settings.

## About phone

Set the system software update method and view the phone status such as the network type, signal strength, battery power level, and network name. You can also check the battery use of individual applications or view the legal information and software version of your phone. See “Checking information about your phone” in this chapter for details.

## Changing display settings

---

### Adjusting the screen brightness manually

1. Press HOME  > MENU, and then tap **Settings** > **Sound & display**.
2. Scroll down the screen, and then tap **Brightness**.
3. Clear the **Automatic brightness** check box.
4. Drag the brightness slider to the left to decrease or to the right to increase the screen brightness. Tap **OK**.

### Adjusting the time before the screen turns off

After a period of inactivity, the phone screen turns off to conserve battery power. You can set the idle time before the screen turns off.

1. Press HOME  > MENU, then tap **Settings** > **Sound & display**.
2. Scroll down the screen, and then tap **Screen timeout**.
3. Tap the time before the screen turns off.



To quickly turn off the screen, press the **POWER** button.

### Preventing automatic screen rotation

By default, the screen orientation automatically adjusts depending on how you hold the phone.



Not all application screens support automatic rotation.

1. Press HOME  > MENU, then tap **Settings** > **Sound & display**.
2. Scroll down the screen, and then clear the **Orientation** check box.

### Recalibrating the G-sensor

Recalibrate the screen if you feel that the screen orientation does not respond properly to the way you hold the phone.

1. Press HOME  > MENU, then tap **Settings** > **Sound & display**.
2. Scroll down the screen, and then tap **G-Sensor calibration**.
3. Place the phone on a flat and level surface, and then tap **Calibrate**.
4. After the recalibration process, tap **OK**.



## Switching animation effects on or off

You can turn off the animation or enable only some animations when switching between screens.

1. Press HOME  > MENU, and then tap **Settings > Sound & display**.
2. Scroll down the screen, and then tap **Animation**.
3. On the options menu, select the animation setting you want.

## Keeping the screen on while charging the phone

You can keep the phone screen from turning off while you are charging the phone.

1. Press HOME  > MENU, then tap **Settings**.
2. Scroll down the screen, and then tap **Applications > Development**.
3. Select the **Stay awake** check box.

## Changing sound settings

---

### Setting a sound profile

Switch to vibrate or silent mode, or use the normal phone sound settings.

1. Press HOME  > MENU, and then tap **Settings > Sound & display > Sound profile**.
2. On the Choose a Profile options menu, tap the sound profile you want to use.

### Enabling or disabling audible selection

You can choose to play a sound when you are selecting items onscreen.

1. Press HOME  > MENU, and then tap **Settings > Sound & display**.
2. Scroll down the screen, and then select or clear the **Audible selection** check box.

### Enabling or disabling haptic feedback

When haptic feedback is enabled (default), your wireless device vibrates every time you press the soft keys on the front panel, or tap onscreen buttons and other onscreen elements.

1. Press HOME  > MENU, and then tap **Settings > Sound & display**.
2. Scroll down the screen, and then select or clear the **Haptic feedback** check box.

### Choosing the notification sound

You can select the sound to play when your phone receives new notifications.



1. Press HOME  > MENU, and then tap **Settings > Sound & display > Notification sound**.
2. Select your preferred notification sound in the list, and then tap **OK**.

## Changing the phone language

---

When you turn your phone on for the first time, you are prompted to select the language you would like to use. You can also change the language on the fly whenever you like. Changing the language adjusts the keyboard layout, date and time formatting, and more.

The languages available to choose from may depend on the version of phone you have.

1. Press HOME  > MENU, and then tap **Settings > Language & keyboard > Select locale**.
2. Tap the language and corresponding region you want to use.
3. Press HOME  to return to the Home screen. You may need to wait briefly as the new language is applied to your phone.

## Optimizing your phone's battery life

---

When you're on the go, it's not always easy to charge your phone's battery as often as you'd like. Follow these tips to extend the time between charges:

- Turn off wireless functions such as Bluetooth, Wi-Fi, and data connection when you're not using them. See the Internet and Bluetooth chapters for details.
- Do not use GPS satellites to determine your GPS location. See the Maps & Location chapter for details.
- Lower the screen brightness. See "Adjusting the screen brightness manually" in this chapter for details.
- Switch off screen animations. See "Switching animation effects on or off" in this chapter for details.
- Cut down on activities such as Internet browsing. Wireless data consumes a lot of power.
- Avoid making very long phone calls or using the camera for extended periods of time.
- Consider carrying a spare battery for times when you can't charge your battery for an extended period.
- Batteries gradually lose storage capacity over time. Consider replacing your battery after eight months to a year, or if you notice that the battery life is decreasing.

### Checking the power usage of applications

1. Press HOME  > MENU, and then tap **Settings**.
2. Scroll down the screen, and then tap **About phone** > **Battery** > **Battery use**.

# Managing memory

---

## Checking how much phone memory is available for use

1. Press HOME  > MENU, and then tap **Settings**.
2. Scroll down the screen, and then tap **SD card & phone storage**. The available phone memory is displayed in the Internal phone storage section.

## Checking the available storage card space

1. Press HOME  > MENU, and then tap **Settings**.
2. Scroll down the screen, and then tap **SD card & phone storage**. The total and available storage card space is displayed in the **SD card** section.

## Clearing application cache and data

1. Press HOME  > MENU, and then tap **Settings**.
2. Scroll down the screen, and then tap **Applications > Manage applications**.
3. On the Manage applications screen, tap the application whose cache and/or data you want to delete.



Press MENU to bring up sort and filter options.

4. In the Application info screen, tap **Clear data** and/or **Clear cache**.

## Uninstalling third-party applications

You cannot uninstall applications that are preinstalled on the phone.

1. Press HOME  > MENU, and then tap **Settings**.
2. Scroll down the screen, and then tap **Applications > Manage applications**.
3. Press MENU, and then tap **Filter > Downloaded**.
4. On the Manage applications screen, tap the application you want to uninstall.
5. On the Application info screen, tap **Uninstall**.

## Freeing up more phone memory or storage card space

If your phone is running low on memory, try the following:

- In your web browser, clear all temporary Internet files and history information. See the Internet chapter for more information.
- Uninstall downloaded programs from Android Market you no longer use. See “Finding and Installing Apps from Android Market “ in the More apps chapter for details.

## Checking information about your phone

---

1. Press HOME  > MENU, and then tap **Settings**.
2. Scroll down the screen, and then tap **About phone**.
3. Select one of the following:

### **System updates**

Tap to check for software updates for your phone.

### **Network**

Check information about Verizon Wireless and its service status.

### **Phone identity**

Check information about your phone.

### **Battery**

Check information about the battery such as its current battery level, status, and what programs are using the battery.

### **Hardware information**

Check the Wi-Fi MAC and Bluetooth addresses.

### **Software information**

Check the version and other information about the Android platform being used by the phone. You can also check the version of the web browser.

### **Legal information**

Read legal information from HTC and Google, and licenses used by the phone.

# Backup, update and reset

## Backing up your contacts

---

Your phone features Verizon Backup Assistant, which automatically backs up your contacts to an online server. You must first create an account on the Verizon Wireless website.

You can set up the Backup Assistant when you first turn on your phone. See “Getting started” in the Basics chapter for details.

If you did not set up Backup Assistant when you first turned on your phone, you can set it up in Settings.

### Setting up Backup Assistant

If you did not set up Backup Assistant during when you first turned on your phone, you can enable it in Settings.

1. Press HOME  > MENU, and then tap **Settings**.
2. Scroll down the screen, and then tap **Accounts & sync**.
3. Tap **Backup Assistant**.
4. Follow the instructions on the screen to sign in to Backup Assistant and back up your contacts.

### Changing the backup schedule

1. Press HOME  > MENU, and then tap **Settings**.
2. Scroll down the screen, and then tap **Accounts & sync**.
3. Tap **Backup Assistant**.
4. Tap **Schedule** and select a backup option from the menu.

### Manually backing up your contacts

1. Press HOME  > MENU, and then tap **Settings**.
2. Scroll down the screen, and then tap **Accounts & sync**.
3. Tap **Backup Assistant**.
4. Tap **Sync now**.

For more information on how to use Backup Assistant and to create a Backup Assistant account, go to: [https://wbillpay.verizonwireless.com/vzw/nos/ba\\_nab/overview\\_def.jsp](https://wbillpay.verizonwireless.com/vzw/nos/ba_nab/overview_def.jsp)

## Updating your phone's system software

---

From time to time, system software updates for your phone may be available. Your phone can check and then notify you if an update is available. You can then download and install the update to your phone.

Depending on the type of update, the update may erase all your personal data and customized settings, and also remove any programs you have installed. Make sure that you have backed up the information and files you want to keep.



Checking and downloading system software updates may incur additional data transfer fees from Verizon Wireless.

1. When there is an update available, the Install system software update dialog box will appear onscreen.
2. On the dialog box, select **Install now**, and then tap **OK**.



Select **Install later** if you want to install the system update at a later time. When you are ready to install, open the Notifications panel, and then tap **System update is ready**.

3. Wait for the update process to finish. When the update is finished, the phone will automatically reset.

### Checking for phone system software updates manually

1. Press HOME  > MENU, then tap **Settings**.
2. Scroll down the screen, and then tap **About phone** > **System updates**.

Your phone checks for system software updates. If no update is available the message “Your system is currently up to date.” appears.



## Performing a hard/factory reset

---

You can return your phone to its original state, as it was when it left the factory. This is also called a hard reset. You might want to do this if you are giving your phone to a friend or relative and you want to remove all your data first, or if your phone has a persistent problem that is not solved by powering off the phone and then powering it on again.

A factory reset is a drastic measure. It permanently erases all your personal data and customized settings, and also removes any programs you have installed. Make sure that you have backed up the information and files you want to keep.



If your phone hangs or freezes, we recommend that you do a “soft” reset instead of a hard/factory reset. To perform a soft reset, remove the battery, wait for a few seconds, and then re-install it. After re-installing the battery, turn on the phone.

### Performing a factory reset via settings

The most convenient way to do a factory reset is via the phone settings.

1. Press HOME  > MENU, then tap **Settings**.
2. Scroll down the screen, and then tap **Privacy > Factory data reset**.
3. On the Factory data reset screen, tap **Reset phone**, and then tap **Erase everything**.

### Performing a factory reset using phone buttons

If you cannot turn on your phone or access the phone settings, you can still perform a factory reset by using the buttons on the phone.

1. With the phone turned off, press and hold the VOLUME DOWN button, and then briefly press the POWER button.
2. Wait for the screen with the 3 Android images to appear, and then release the VOLUME DOWN button.
3. Press VOLUME DOWN to select **CLEAR STORAGE**, and then press POWER.
4. When asked to confirm, press VOLUME UP.

# Specifications

CPU speed	1 GHz
Platform	Android™ 2.1 (Éclair) with HTC Sense™
Memory	ROM: 512 MB RAM: 576 MB
Dimensions (LxWxT)	4.63 x 2.30 x 0.47 inches (117.5 x 58.5 x 11.9 mm)
Weight	4.6 ounces (130 grams) with battery
Display	3.7-inch AMOLED touch-sensitive screen with 480 X 800 WVGA resolution
Network	<ul style="list-style-type: none"><li>▪ Dual-band (800 and 1900 MHz)</li><li>▪ CDMA2000 1xRTT/1xEVDO/1xEVDO rev. A and IS-95A/B voice or data with up to 1.8 Mbps uplink and 3.1 Mbps downlink speeds (Band frequency and data speed are operator dependent.)</li></ul>
Onscreen navigation	Optical joystick
GPS	Internal GPS antenna
Sensors	G-Sensor Digital compass Proximity sensor Ambient light sensor
Connectivity	<ul style="list-style-type: none"><li>▪ Bluetooth® 2.1 with FTP/OPP for file transfer, A2DP for wireless stereo headsets, and PBAP for phonebook access from the car kit</li><li>▪ Wi-Fi®: IEEE 802.11 b/g/n</li><li>▪ 3.5 mm stereo audio jack</li><li>▪ micro-USB (12-pin micro-USB 2.0)</li></ul>
Camera	8 megapixel color camera with auto focus and flash
Audio supported formats	<ul style="list-style-type: none"><li>▪ Playback: .aac, .amr, .ogg, .m4a, .mid, .mp3, .wav, .wma</li><li>▪ Recording: .amr</li></ul>
Video supported formats	<ul style="list-style-type: none"><li>▪ Playback: .3gp, .3g2, .mp4, .wmv</li><li>▪ Recording: .3gp</li></ul>
Battery	<ul style="list-style-type: none"><li>▪ Rechargeable Lithium-ion battery</li><li>▪ Capacity: 1300 mAh</li><li>▪ Talk time: Up to 313 minutes</li><li>▪ Standby time: Up to 146 hours</li></ul> (The above are subject to network and phone usage.)
Expansion slot	microSD™ memory card (SD 2.0 compatible)
AC adapter	Voltage range/frequency: 100 ~ 240V AC, 50/60 Hz DC output: 5V and 1A
Special features	Friend Stream



Specifications are subject to change without prior notice.

# Index

## Symbols

3G 125

## A

Adding a city to the Weather screen 123  
Adding a city to the World Clock screen 120  
Adding a new contact 54  
Adding application icons and other shortcuts on  
your Home screen 37  
Adding a widget to your Home screen 36  
Adding folders on your Home screen 38  
Adjusting the volume 28  
Airplane Mode 51  
Alarm clock 121  
Album (Photos application) 152  
Android Market 186  
Answering an incoming call 43  
Audio supported formats 202

## B

Backing up contacts 199  
Backing up your contacts to the storage card 56  
Battery times 202  
Bluetooth 139

- connecting headset or car kit 140
- sending and receiving information 142
- sending photos or videos 157

Bookmarks 136  
Browser 131

## C

Calendar application 106  
Calendar widget 115  
Call history 47  
Call services 49  
Camera 145  
Capturing video 149  
Changing your wallpaper 35  
Checking information about your phone 198  
Checking weather 123  
Clock 116  
Clock widget (HTC) 116  
Conference call 45  
Connecting your phone to a computer 29  
Copying files to and from the storage card 30  
Creating a calendar event 106

Creating a playlist 161  
Cropping a photo 156  
Customizing and saving a scene 33

## D

Data connection 125  
Date and time 119  
Deleting a scene 34  
Deleting contacts 56  
Desk Clock 118  
Downloading HTC widgets 36

## E

Editing a contact's information 55  
Email 94

- adding a POP3/IMAP account 101
- deleting 96, 102
- sending 97, 104
- sending photos or videos 157
- settings 100, 105

Ending a call 46  
Event reminders 112  
Exchange ActiveSync 77  
Extended Home screen 24

## F

Facebook

- sharing photos 158

Facebook for Android 82  
Facebook for HTC Sense 82  
Factory reset 201  
Finger gestures 20  
Flash (camera) 148  
Flickr 158  
FM Radio 181  
Folders 38  
Footprints 172  
Friend Stream 87

- Friend Stream widget 88

## G

Gmail/Google Mail 94  
Google Accounts 76  
Google Maps 164  
GPS satellites 164

**H**

Hard reset 201  
 Home city 119  
 Home page 131  
 Home screen 24  
 Home screen wallpaper 35  
 HTC Clock widget 116  
 HTC Sync 78

**I**

Importing contacts from the storage card 56  
 Internet 125  
 Inviting guests to your event (Google Account only) 107

**K**

Keyboard 62

**L**

Library (Music) 160  
 Listening to the radio 181  
 Location sources 164

**M**

Mail 101  
 Making an emergency call 42  
 Making Calls 40  
 Managing memory 197  
 Maps 164  
 Meeting request 103, 107  
 Memory 202  
 Merging contact information 55  
 Messages 67  
 Microsoft Exchange ActiveSync 77  
 Missed call 48  
 MMS 67  
 Mobile network connection 125  
 Music application 159  
 Music widget 163  
 Mute the microphone 46

**N**

Navigator 185  
 Notification icons 26  
 Notification ringtone 194  
 Notifications panel 27

**O**

Onscreen keyboard 62  
 Optimizing your phone's battery life 196

**P**

PDF Viewer 177  
 Peep 84  
 - widget 86  
 People 52  
 - contact groups 58  
 - contact information and conversations 60  
 - People screen 53  
 - People widget 61  
 Personalizing 32  
 Phone status icons 25  
 Photo capture 148  
 Photos application 152  
 Picasa 158  
 Picture message 67  
 Playing music 159  
 Playlist 161  
 Protecting your phone with a screen lock 189

**Q**

Quickoffice 178  
 Quick Search Box 31

**R**

Rearranging or removing widgets and icons on your Home screen 39  
 Recalibrating the G-sensor 192  
 Recording your voice 183  
 Rejecting a call and sending a text message 44  
 Rejecting an incoming call 44  
 Removing the back cover 17  
 Renaming a scene 34  
 Review screen (Camera) 146  
 Ringtone 163  
 Rotating and saving a photo 156

**S**

Scenes 33  
 Search 31  
 Searching for a contact 56  
 Searching your phone and the Web 31  
 Sending a meeting request using Calendar (Exchange ActiveSync only) 107  
 Sending a photo or video by MMS 157  
 Sending a vCalendar 115  
 Sending contact information 56  
 Sending music using Bluetooth 163  
 Sending photos or videos by email 157  
 Sending photos or videos using Bluetooth 157

Setting a song as ringtone 163

Settings 190

- alarm sound 122
- calendar 114
- camera 150
- display settings 192
- phone language 195
- sound settings 194
- weather 124

Setting the time zone, date, and time 119

Setting up My contact card 53

Setting up your phone for the first time 21

Setting your home city 119

Sharing photos on Facebook 158

Sharing photos on Flickr 158

Sharing photos on Picasa 158

Sharing videos on YouTube 158

Shortcuts 37

Sleep mode 22

SMS 67

Social network accounts 76

Speakerphone 46

Specifications 202

Speed dial 40

Stocks 179

Stopwatch 117

Sync with computer 78

Sync with online accounts 76

**T**

Taking a photo 148

Tethering 138

Text message 67

Timer 117

Time zone 119

Turning off your phone 21

Turning on your phone 21

Twitter 84

Twittering on your phone 84

**U**

Uninstalling third-party applications 197

Updating your phone's system software 200

Using your phone as a modem 138

**V**

vCalendar 115

Video capture 149

Videos 175

Video supported formats 202

Viewfinder screen (Camera) 145

Viewing a PDF 177

Viewing photos and videos 153

Viewing photos on Facebook 155

Viewing photos on Flickr 155

Visual Voice Mail 50

Voice input 64

Voice Recorder 183

Voice Search 184

VPN 129

**W**

Wallpaper 35

WAP push messages 71

Watching video (Photos application) 154

Weather 123

Weather widget 124

Web browser 131

Wi-Fi 126

Widgets 36, 39

World Clock 119

**Y**

Your phone 14

- charging the battery 19
- inserting the battery 18
- inserting the storage card 17
- removing the battery 18
- removing the storage card 17
- replacing the bottom cover 17

YouTube 158, 175

**Z**

Zooming (camera) 147

Zooming in or out on a photo 154

